



HUGO
LIGHTING
Catalogue

RESIDENTIAL • COMMERCIAL • INDUSTRIAL

WELCOME TO HUGO LIGHTING

Hugo Lighting has been operating in the lighting industry for the past 10 years supplying electrical wholesalers. We offer one of the most comprehensive lighting ranges available for residential, commercial and industrial applications.

Our mission is to provide exceptional customer service and quality products engineered and designed for the New Zealand market, all backed with industry leading warranties and exceptional quality control.

Today's market is focused on energy efficient lighting solutions that offer high lumen output, low energy consumption and long product life.

At Hugo Lighting we take these requirements seriously and seek to deliver solutions that incorporate all of these elements.

Most Hugo Lighting products are now Solid State LED, either Surface Mounted Diode (SMD) or Chips on Board (COB), which meet the market requirements. These are all packaged in both form and function as innovative lighting solutions for your next project whether your own home or a residential, commercial or industrial development.

Lighting should be considered the fourth dimension of architecture, there to complement and enhance the project. At Hugo Lighting we believe lighting a space is an art as well as a science, so we always design our solutions to create light and shade in a space whilst at the same time meeting all relevant lighting standards.























In this catalogue we are confident that there will be a range of products to suit your next project. However, this is just the start of the lighting selection process; the placement, quantity and colour rendering are all important elements to consider when lighting a space.

Lighting should create the right atmosphere and therefore it is important to be able to control the dimming and lighting levels in the space. There are various analogue and digital dimming systems available in the market today and you can be assured that Hugo Lighting products will be compatible with these and enhance your project.

To view and download product technical specifications and SDoc compliance documentation, please visit hugolighting.com. If you would like to find out more about our latest products and promotions, you can also find us on Facebook.

The Hugo Lighting team is ready to assist in the design and selection process of your next project and we look forward to hearing from you.

Mark Ralston
Owner

| | | |
|---|-------------------------------|-----|
|  | PENDANTS..... | 4 |
|  | LINEAR EXTRUSIONS..... | 12 |
|  | SURFACE..... | 19 |
|  | DOWNLIGHTS..... | 27 |
|  | INDOOR WALL LIGHTS..... | 45 |
|  | MARKERS..... | 50 |
|  | OUTDOOR WALL LIGHTS..... | 52 |
|  | GROUND LIGHTS..... | 69 |
|  | FLOODLIGHTS..... | 78 |
|  | HIGHBAYS..... | 84 |
|  | BATTENS..... | 88 |
|  | UNDER VERANDAH..... | 90 |
|  | CABINET..... | 92 |
|  | SENSORS..... | 95 |
|  | PANELS..... | 96 |
|  | EMERGENCY EXIT..... | 102 |
|  | LED STRIP..... | 105 |
|  | LED STRIP - EXTRUSION..... | 109 |
|  | CONSTANT VOLTAGE DRIVERS..... | 111 |
|  | CONSTANT CURRENT DRIVERS..... | 112 |
|  | TECHNICAL SPECIFICATION..... | 113 |
|  | INDEX..... | 115 |

PENDANTS

Ideal for dining areas, bars, bench and kitchen tops and even in commercial projects for that unique and special finishing touch. Made from hand blown glass and spun and formed metal, each fitting is unique and distinctive.

The range of concrete pendants have a distinctive and original design that will bring a Nordic urban and industrial look to your next project.







Each fitting is handcrafted and individual with a natural concrete finish. Comes complete with a 1500mm suspension cord and chrome ceiling canopy.

Interesting lighting effects and moods may be obtained when fitted with GLS clear filament lamps or the LED equivalents (not included) especially when dimmed.

WATTS
LAMP
INPUT
DIMMABLE
HEIGHT
DIAMETER
LENGTH
MATERIAL

PEN441









| | | |
|---|---|---|
|  WATTAGE 60W |  LAMP E27 |  VOLTAGE 230V |
|  DIMMABLE Yes |  DIAMETER 160mm |  MATERIAL Steel |

| | |
|----------|--------|
| WATTS | 60W |
| LAMP | E27 |
| INPUT | 230V |
| DIMMABLE | Yes |
| HEIGHT | 1500mm |
| DIAMETER | 160mm |
| LENGTH | 160mm |
| MATERIAL | Steel |

PEN442









| | | |
|---|---|---|
|  WATTAGE 100W |  LAMP E27 |  VOLTAGE 230V |
|  DIMMABLE Yes |  DIAMETER 220mm |  MATERIAL Steel |

| | |
|----------|--------|
| WATTS | 100W |
| LAMP | E27 |
| INPUT | 230V |
| DIMMABLE | Yes |
| HEIGHT | 1500mm |
| DIAMETER | 220mm |
| LENGTH | 220mm |
| MATERIAL | Steel |

PEN443



| | | |
|---|---|---|
|  WATTAGE 100W |  LAMP E27 |  VOLTAGE 230V |
|  DIMMABLE Yes |  DIAMETER 300mm |  MATERIAL Steel |

| | |
|----------|--------|
| WATTS | 100W |
| LAMP | E27 |
| INPUT | 230V |
| DIMMABLE | Yes |
| HEIGHT | 1500mm |
| DIAMETER | 300mm |
| LENGTH | 300mm |
| MATERIAL | Steel |

PEN532



GLASS & MATT BLACK BASE



WATTAGE
60W
LAMP
E27
VOLTAGE
230V
DIMMABLE
Yes
DIAMETER
200mm
MATERIAL
Glass

| | |
|----------|--------|
| WATTS | 60W |
| LAMP | E27 |
| INPUT | 230V |
| DIMMABLE | Yes |
| HEIGHT | 1500mm |
| DIAMETER | 200mm |
| LENGTH | 200mm |
| MATERIAL | Glass |

PEN533



GLASS & MATT BLACK BASE



WATTAGE
60W
LAMP
E27
VOLTAGE
230V
DIMMABLE
Yes
DIAMETER
200mm
MATERIAL
Glass

| | |
|----------|--------|
| WATTS | 60W |
| LAMP | E27 |
| INPUT | 230V |
| DIMMABLE | Yes |
| HEIGHT | 1500mm |
| DIAMETER | 200mm |
| LENGTH | 200mm |
| MATERIAL | Glass |

PEN534

BR C G



GLASS & GOLD



WATTAGE
60W
LAMP
E27
VOLTAGE
230V
DIMMABLE
Yes
DIAMETER
160mm
MATERIAL
Glass

| | |
|----------|--------|
| WATTS | 60W |
| LAMP | E27 |
| INPUT | 230V |
| DIMMABLE | Yes |
| HEIGHT | 1500mm |
| DIAMETER | 160mm |
| LENGTH | 160mm |
| MATERIAL | Glass |

PEN542



CONCRETE



WATTAGE
100W
LAMP
E27
VOLTAGE
230V
DIMMABLE
Yes
DIAMETER
240mm
MATERIAL
Concrete

| | |
|----------|----------|
| WATTS | 100W |
| LAMP | E27 |
| INPUT | 230V |
| DIMMABLE | Yes |
| HEIGHT | 1500mm |
| DIAMETER | 240mm |
| LENGTH | 240mm |
| MATERIAL | Concrete |



INDOOR



PENDANTS

PEN427

MW

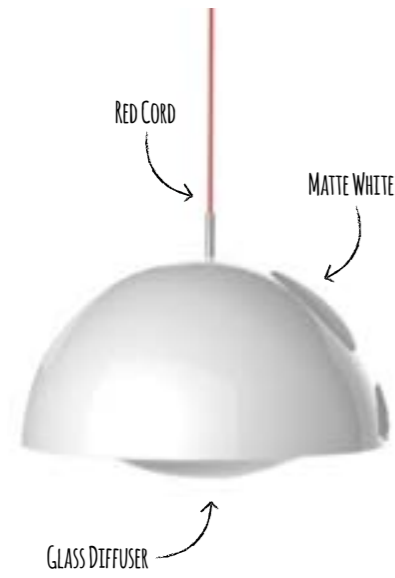

WATTAGE **3x60W**
 LAMP **E27**
 VOLTAGE **230V**
 DIMMABLE **Yes**
 DIAMETER **500mm**
 LENGTH **500mm**

PEN425

W



WATTAGE **100W**
 LAMP **E27**
 VOLTAGE **230V**
 DIMMABLE **Yes**
 DIAMETER **350mm**
 LENGTH **200mm**

| | |
|----------|---------|
| WATTS | 3 x 60W |
| LAMP | E27 |
| INPUT | 230V |
| DIMMABLE | Yes |
| HEIGHT | 1500mm |
| DIAMETER | 500mm |
| LENGTH | 500mm |

PEN426

W

BK

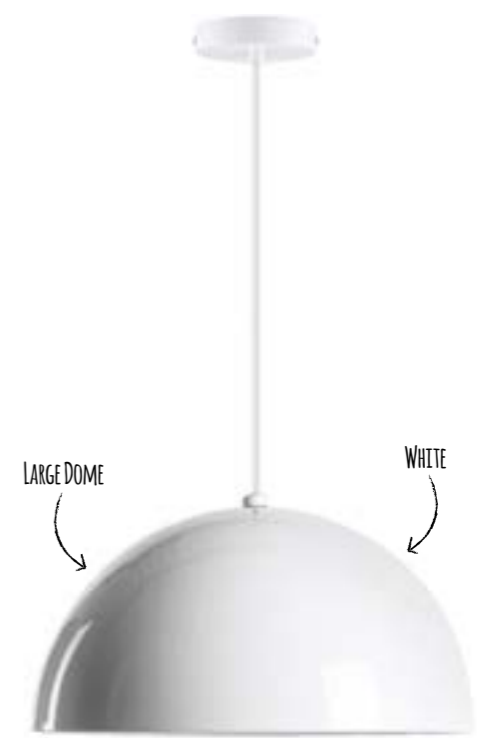

WATTAGE **100W**
 LAMP **E27**
 VOLTAGE **230V**
 DIMMABLE **Yes**
 DIAMETER **500mm**
 LENGTH **330mm**

| | |
|----------|--------|
| WATTS | 100W |
| LAMP | E27 |
| INPUT | 230V |
| DIMMABLE | Yes |
| HEIGHT | 1500mm |
| DIAMETER | 500mm |
| LENGTH | 330mm |



INDOOR



PENDANTS





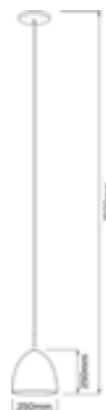

PEN461

B

O

G









| | | |
|---|---|--|
|  WATTAGE 15W |  LAMP E27 |  VOLTAGE 230V |
|  DIMMABLE Yes |  DIAMETER 250mm |  MATERIAL Silicone |

| | | |
|----------|----------|--------|
| WATTS | 15W CFL | 3 x 5W |
| LAMP | E27 | LED |
| INPUT | 230V | 230V |
| DIMMABLE | Yes | No |
| HEIGHT | 1500mm | 1500mm |
| DIAMETER | 250mm | 300mm |
| LENGTH | 250mm | 34mm |
| MATERIAL | Silicone | - |

PEN521

W









| | | |
|---|---|---|
|  WATTAGE 3x5W |  LAMP LED |  VOLTAGE 230V |
|  DIMMABLE No |  DIAMETER 300mm |  LED COLOUR 3000K |

| | |
|----------|--------|
| WATTS | 3 x 5W |
| LAMP | LED |
| INPUT | 230V |
| DIMMABLE | No |
| HEIGHT | 1500mm |
| DIAMETER | 300mm |
| LENGTH | 34mm |
| MATERIAL | - |

PEN431

MW









| | | |
|---|---|---|
|  WATTAGE 40W |  LAMP G9 |  VOLTAGE 230V |
|  DIMMABLE Yes |  DIAMETER 110mm |  LENGTH 100mm |

| | | |
|----------|--------|-------------|
| WATTS | 40W | 10 x 1W LED |
| LAMP | G9 | LED |
| INPUT | 230V | 230V |
| DIMMABLE | Yes | No |
| HEIGHT | 1500mm | 1500mm |
| DIAMETER | 110mm | 110mm |
| LENGTH | 100mm | 10mm |
| MATERIAL | - | - |

PEN523

MW



| | | |
|--|---|---|
|  WATTAGE 10x1W |  LAMP LED |  VOLTAGE 230V |
|  DIMMABLE No |  DIAMETER 110mm |  LED COLOUR 3000K |

| | |
|----------|-------------|
| WATTS | 10 x 1W LED |
| LAMP | LED |
| INPUT | 230V |
| DIMMABLE | No |
| HEIGHT | 1500mm |
| DIAMETER | 110mm |
| LENGTH | 10mm |
| MATERIAL | - |

LED LINEAR EXTRUSION

Introducing our new bespoke “build your own” LED linear extrusion range. A must have in any architectural home or commercial application.

Select your channel: suspended, surface mounted or recessed.

Select your colour: white or black.

Select your length.

Select your insert module: grid light, spotlight, wall washer, general light, accent light or microprismatic.

Select your colour temperature.

Built to your exact specification.

Our LED linear extrusion range are indent lines and have a 6 week lead time.

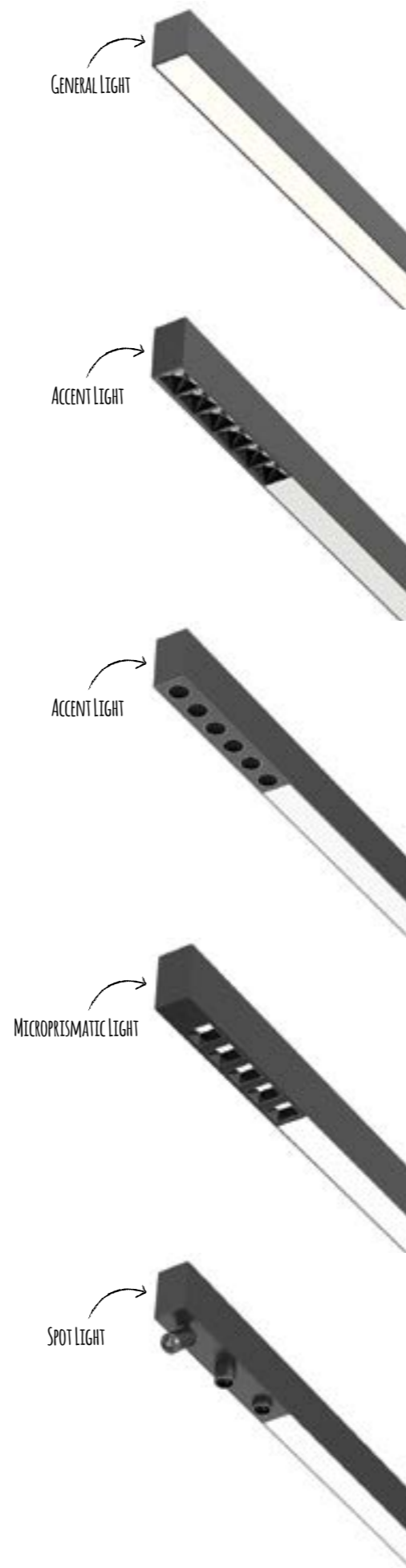

CHANNELS

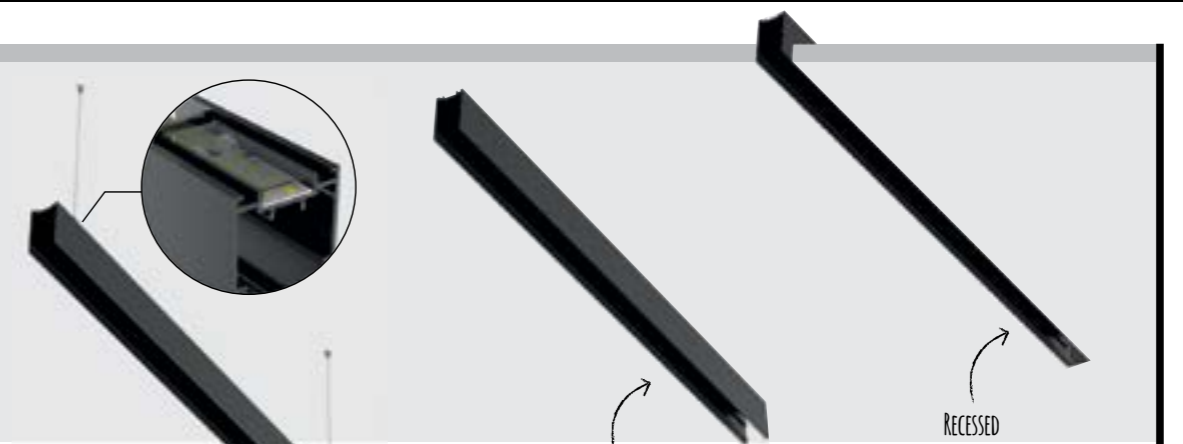

INSERTS

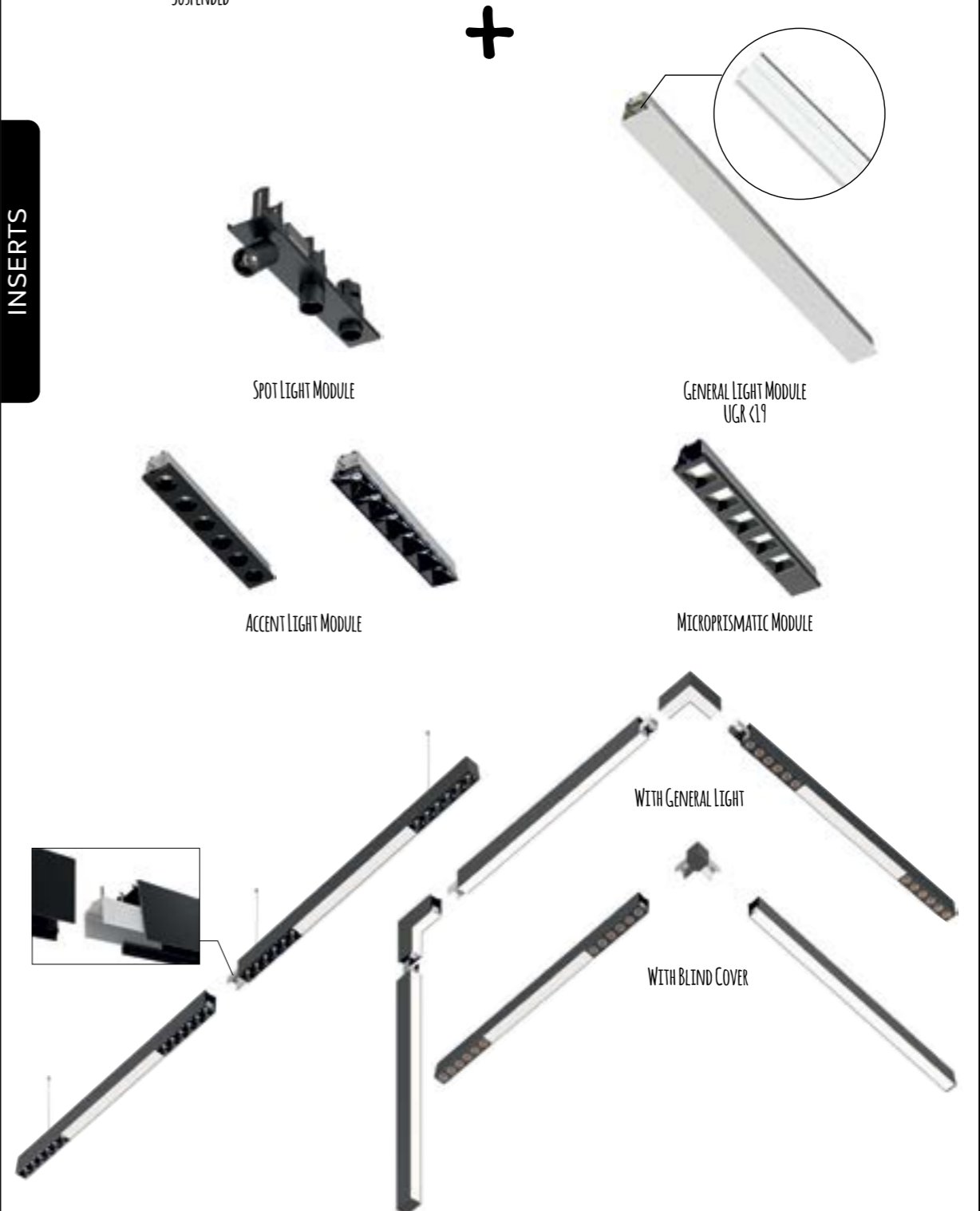

ALG1200/1800

BK MW

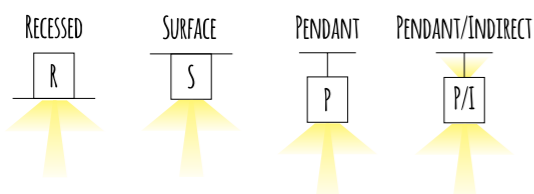
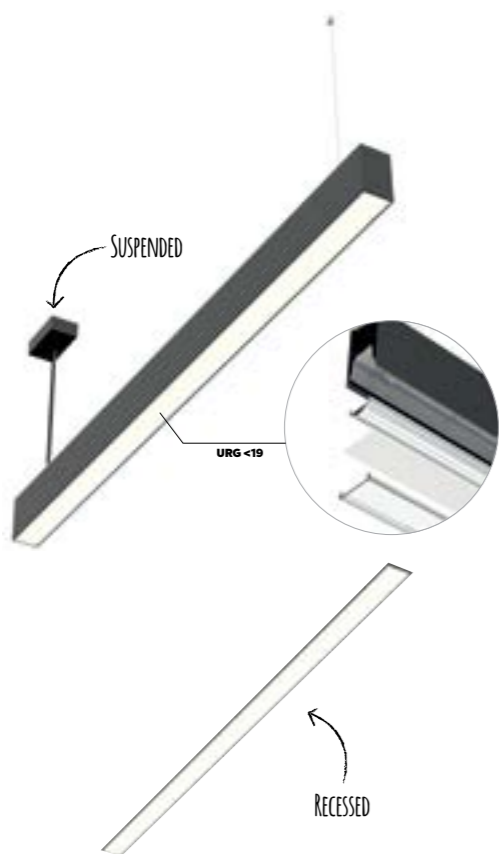

CRI
83+

PROJECTION
85mm

BEAM ANGLE
65°

ALG1200

ALG1800

| | | |
|-------------|------------|--------|
| WATTS | 26W | 36W |
| LUMEN | 1800lm | 2600lm |
| OVERALL | 85 x 50mm | |
| LENGTH | 1120mm | 1680mm |
| DIMMABLE | No | |
| DIFFUSER | Opal Cover | |
| BEAM | 65° | 40° |
| COLOUR TEMP | 3000K | |
| CRI | 83+ | 90+ |
| UGR | <19 | |

ALR1200/1800

BK MW

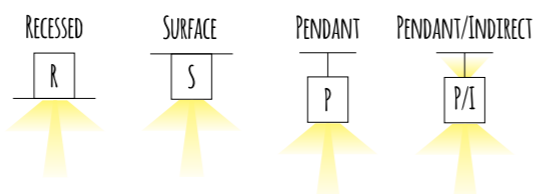
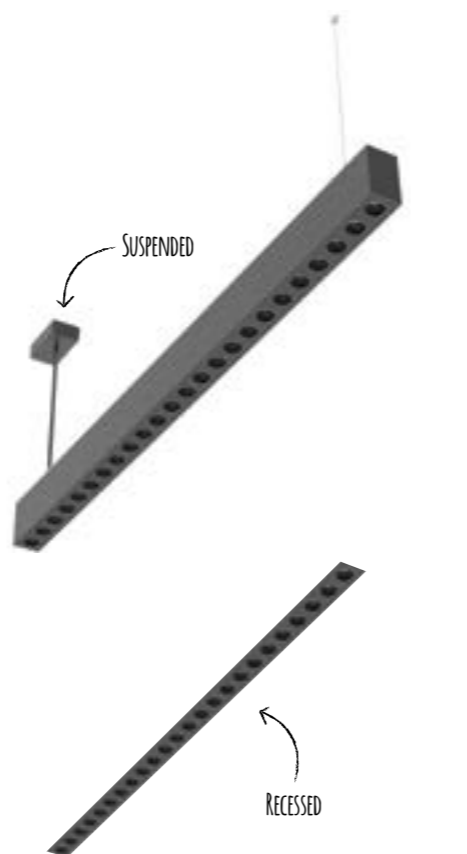

CRI
90+

PROJECTION
85mm

BEAM ANGLE
40°

ALR1200

ALR1800

| | | |
|-------------|-----------|--------|
| WATTS | 60W | 90W |
| LUMEN | 4400lm | 6600lm |
| OVERALL | 85 x 50mm | |
| LENGTH | 1120mm | 1680mm |
| DIMMABLE | No | |
| DIFFUSER | - | |
| BEAM | 40° | 40° |
| COLOUR TEMP | 3000K | |
| CRI | 90+ | 90+ |
| UGR | <19 | |

ALM1200/1800

BK MW

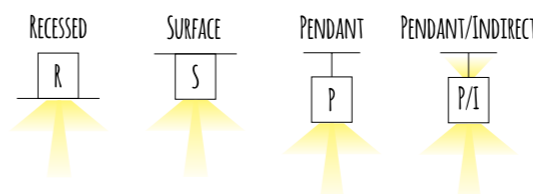
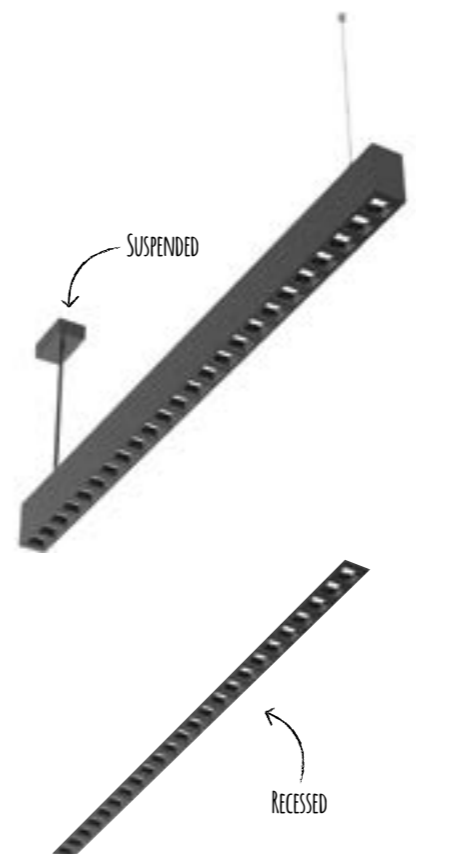

CRI
90+

PROJECTION
85mm

BEAM ANGLE
45°

ALM1200

ALM1800

| | | |
|-------------|-----------|-----------------|
| WATTS | 56W | 84W |
| LUMEN | 4800lm | 7000lm |
| OVERALL | 85 x 50mm | |
| LENGTH | 1120mm | 1680mm |
| DIMMABLE | No | |
| DIFFUSER | - | |
| BEAM | 45° | 15° / 30° / 55° |
| COLOUR TEMP | 3000K | |
| CRI | 90+ | 90+ |
| UGR | <19 | |

ALW1200/1800

BK MW

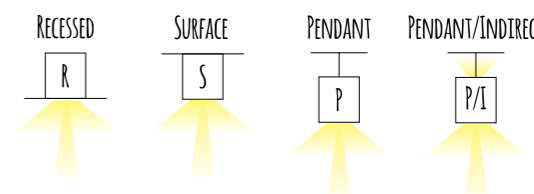
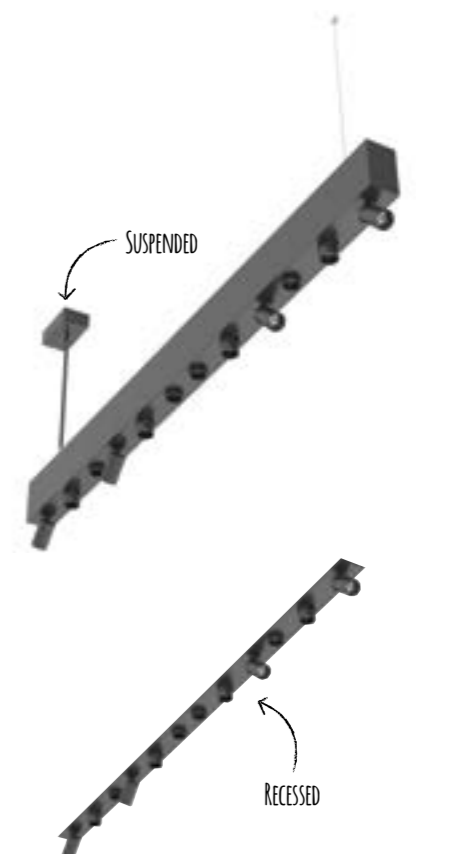

CRI
90+

PROJECTION
85mm

BEAM ANGLE
15°/30°/55°

ALW1200

ALW1800

COMBINATION

ALCGR1200/1800

BK MW

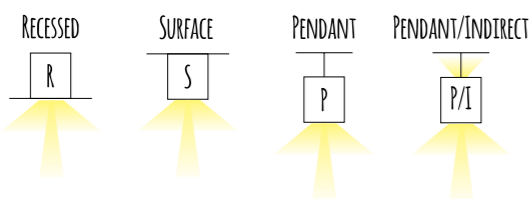
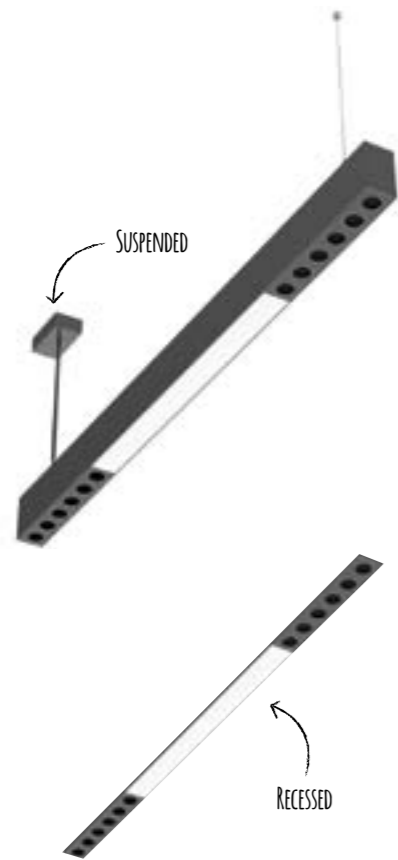

CRI **90+**
 PROJECTION **85mm**
 BEAM ANGLE **40°/65°**

ALCGR1200

ALCGR1800

| | | |
|-------------|-----------|--------|
| WATTS | 42W | 63W |
| LUMEN | 3000lm | 4500lm |
| OVERALL | 85 x 50mm | |
| LENGTH | 1120mm | 1680mm |
| DIMMABLE | No | |
| DIFFUSER | - | |
| BEAM | 40° / 65° | |
| COLOUR TEMP | 3000K | |
| CRI | 90+ | |
| UGR | <19 | |

COMBINATION

ALCGM1200/1800

BK MW

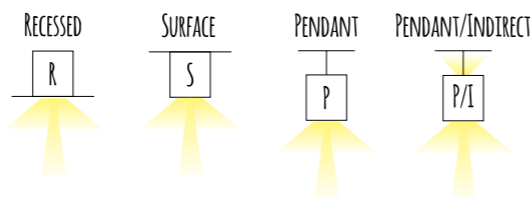
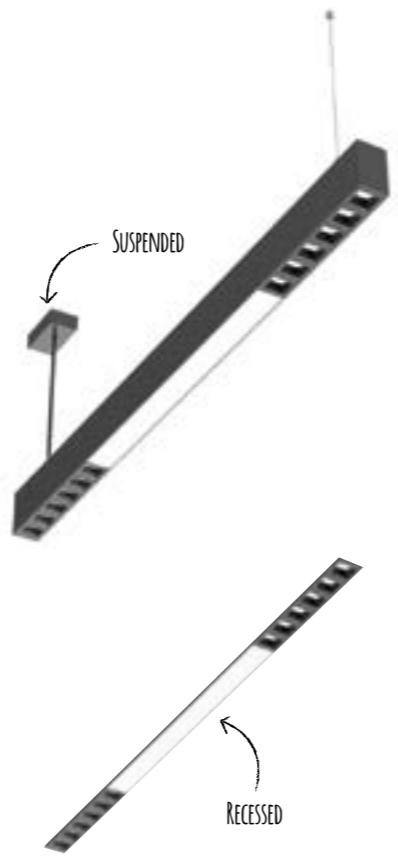

CRI **90+**
 PROJECTION **85mm**
 BEAM ANGLE **45°/65°**

ALCGM1200

ALCGM1800

| | | |
|-------------|-----------|--------|
| WATTS | 38W | 57W |
| LUMEN | 3500lm | 5250lm |
| OVERALL | 85 x 50mm | |
| LENGTH | 1120mm | 1680mm |
| DIMMABLE | No | |
| DIFFUSER | - | |
| BEAM | 45° / 65° | |
| COLOUR TEMP | 3000K | |
| CRI | 90+ | |
| UGR | <19 | |

COMBINATION

ALCGS1200/1800

BK MW

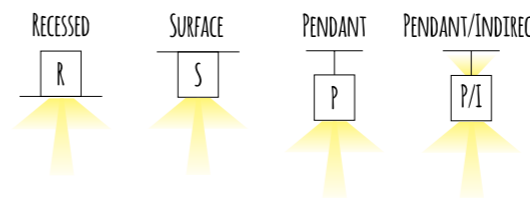
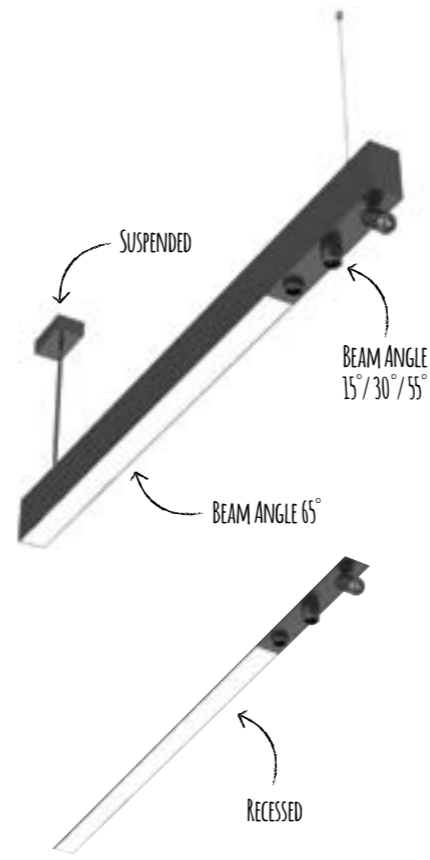

CRI **80/90**
 PROJECTION **85mm**
 BEAM ANGLE **15°+65°**
30°+65°
55°+65°

ALCGS1200

ALCGS1800

| | | |
|-------------|-------------------------|--------|
| WATTS | 33W | 50W |
| LUMEN | 3100lm | 4650lm |
| OVERALL | 85 x 50mm | |
| LENGTH | 1120mm | 1680mm |
| DIMMABLE | No | |
| DIFFUSER | - | |
| BEAM | 15°+65°/30°+65°/55°+65° | |
| COLOUR TEMP | 3000K | |
| CRI | 90+ | |
| UGR | <19 | |

MODULES

GENERAL LIGHT

ACCENT LIGHT RD

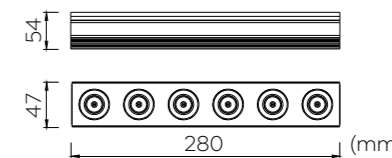

GENERAL LIGHT

ACCENT LIGHT RD

| | | |
|-------------|-----------|--------|
| WATTS | 13W | 15W |
| LUMEN | 850lm | 1100lm |
| OVERALL | 47 x 54mm | |
| LENGTH | 560mm | 280mm |
| DIMMABLE | No | |
| DIFFUSER | - | |
| BEAM | 65° | |
| COLOUR TEMP | 3000K | |
| CRI | 83+ | |
| UGR | <19 | |

MODULES

ACCENT LIGHT SQ



SPOT LIGHT



MICROPRISMATIC



CORNER LIGHT



MODULES

| | ACCENT LIGHT SQ | SPOT LIGHT | MICROPRISMATIC LIGHT | CORNER LIGHT |
|-------------|-----------------|-------------|----------------------|--------------|
| WATTS | 15W | 15W | 15W | 9W |
| LUMEN | 1100lm | 1600lm | 1400lm | 1600lm |
| OVERALL | 47 x 54mm | 47 x 73mm | 47 x 54mm | 50 x 85mm |
| LENGTH | 280mm | 280mm | 280mm | 200mm |
| DIMMABLE | No | No | No | No |
| BEAM | 40° | 15°/30°/55° | 45° | 65° |
| COLOUR TEMP | 3000K | 3000K | 3000K | 3000K |
| CRI | 83+ | 83+ | 83+ | 83+ |
| UGR | <19 | <19 | <19 | <19 |

LED SURFACE

A complete range to suit every project and environment offering high lumen output, reliable and smooth dimming from phase dimmers or digital control.

Some Hugo LED ceiling lights come complete with multi selectable colour temperatures. The simple selection from the dipswitch located on the luminaire will provide 3000K 4000K or 5700K.

SCLG12W

MW



WATTAGE
12W



CRI
80+



IP
IP40



LUMEN
1400lm



DIMMABLE
Yes



COLOUR TEMP
3000K

SCLG25W

MW



WATTAGE
25W



CRI
80+



IP
IP40



LUMEN
2800/3000lm



DIMMABLE
Yes







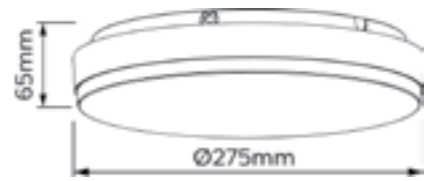

COLOUR TEMP
3000/4000K

| | SCLG12W | SCLG25W3K | SCLG25W4K |
|-------------|---------|-----------|-----------|
| WATTS | 12W | 25W | 25W |
| LUMEN | 1400lm | 2800lm | 3000lm |
| OVERALL | 250mm | 400mm | 400mm |
| PROJECTION | 33mm | 33mm | 33mm |
| DIMMABLE | Yes | Yes | Yes |
| IP | IP40 | IP40 | IP40 |
| BEAM | 100° | 100° | 100° |
| COLOUR TEMP | 3000K | 3000K | 4000K |
| CRI | 80+ | 80+ | 80+ |

SCL3125

MW



| | | |
|--|--|--|
|  WATTAGE 25W |  LUMEN 2400/2900lm |  IP IP54 |
|  CRI 80+ |  DIMMABLE Yes |  3CCT 3 in 1 |

SCL218

MW









| | | |
|--|---|--|
|  WATTAGE 18W |  LUMEN 1700lm |  IP IP54 |
|  CRI 80+ |  DIMMABLE Yes |  COLOUR TEMP 3000K |

| | | |
|-------------|-------------------|--------|
| WATTS | 25W | 18W |
| LUMEN | 2400/2900lm | 1700lm |
| OVERALL | 275mm | 300mm |
| PROJECTION | 65mm | 40mm |
| DIMMABLE | Yes | Yes |
| IP | IP54 | IP54 |
| BEAM | 120° | 120° |
| COLOUR TEMP | 3000K/4000K/5700K | 3000K |
| CRI | 80+ | 80+ |

SCL3218

MW









| | | |
|--|--|--|
|  WATTAGE 18W |  LUMEN 1710-1910lm |  IP IP54 |
|  CRI 80+ |  DIMMABLE Yes |  3CCT 3 in 1 |

| | |
|-------------|-------------------|
| WATTS | 18W |
| LUMEN | 1710/1910lm |
| OVERALL | 300mm |
| PROJECTION | 38mm |
| DIMMABLE | Yes |
| IP | IP54 |
| BEAM | 120° |
| COLOUR TEMP | 3000K/4000K/5700K |
| CRI | 80+ |

SCL3225

MW



| | | |
|--|--|--|
|  WATTAGE 25W |  LUMEN 2175-2600lm |  IP IP54 |
|  CRI 80+ |  DIMMABLE Yes |  3CCT 3 in 1 |

| | |
|-------------|-------------------|
| WATTS | 25W |
| LUMEN | 2175/2600/2500lm |
| OVERALL | 300mm |
| PROJECTION | 38mm |
| DIMMABLE | Yes |
| IP | IP54 |
| BEAM | 120° |
| COLOUR TEMP | 3000K/4000K/5700K |
| CRI | 80+ |

SCL118

MW

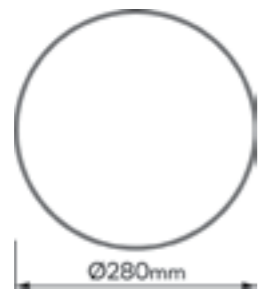





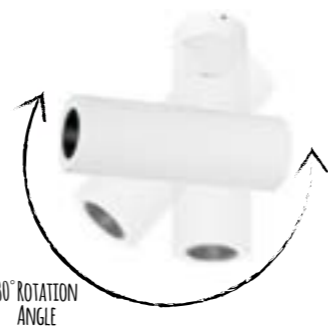
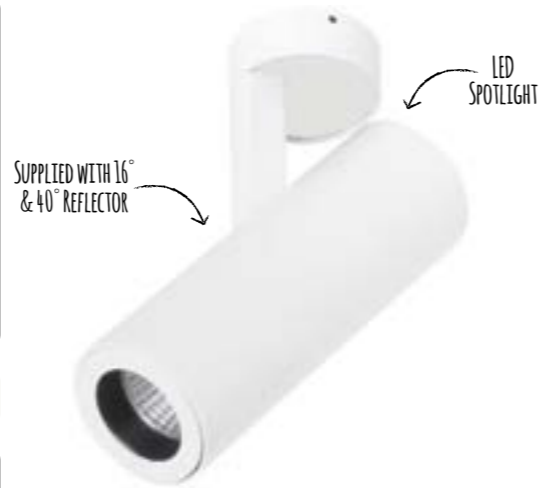

| | | |
|--|---|--|
|  WATTAGE 18W |  LUMEN 1400lm |  IP IP44 |
|  CRI 80+ |  DIMMABLE Yes |  COLOUR TEMP 3000K |

SWL631

MW

BK









| | | |
|--|---|--|
|  WATTAGE 12W |  LUMEN 830lm |  IP IP20 |
|  CRI 95+ |  PROJECTION 205mm |  COLOUR TEMP 3000K |

SWL632

MW

BK









| | | |
|--|---|--|
|  WATTAGE 30W |  LUMEN 2100lm |  IP IP20 |
|  CRI 95+ |  PROJECTION 265mm |  COLOUR TEMP 3000K |

DLEK933

MW

BK



| | | |
|--|---|---|
|  WATTAGE 13W |  LUMEN 1200lm |  IP IP20 |
|  CRI 94+ |  BEAM ANGLE 40° |  DIMMABLE Yes |

DLEK9333K

DLEK9334K

| | | |
|-------------|--------|---------------------------|
| WATTS | 18W | 12W |
| LUMEN | 1400lm | 830lm |
| OVERALL | 280mm | 205 x 63mm |
| PROJECTION | 53mm | 205mm |
| DIMMABLE | Yes | No (dimnable coming soon) |
| IP | IP44 | IP20 |
| BEAM | 120° | 40° (also includes 16°) |
| COLOUR TEMP | 3,000K | 3000K |
| CRI | 80+ | 95+ |

| | | |
|-------------|---------------------------|-------------|
| WATTS | 30W | 13W |
| LUMEN | 2100lm | 1200lm |
| OVERALL | 265 x 90mm | 100 x 100mm |
| PROJECTION | 265mm | 100mm |
| DIMMABLE | No (dimnable coming soon) | Yes |
| IP | IP20 | IP20 |
| BEAM | 38° (also includes 15°) | 40° |
| COLOUR TEMP | 3000K | 4000K |
| CRI | 95+ | 94+ |

DLEK934

MW

BK



WATTAGE
13.7W



LUMEN
1200lm



IP
IP20



CRI
94+



CUTOUT
90mm



BEAM ANGLE
40°

DLEK9343K

DLEK9344K

| | | |
|-------------|--------|---|
| WATTS | 13.7W | 9W |
| LUMEN | 1200lm | 946lm |
| OVERALL | 100mm | 91 x 75mm |
| PROJECTION | 60mm | 91mm |
| DIMMABLE | Yes | Yes |
| IP | IP20 | IP20 |
| BEAM | 40° | 48° (24° & 34° available on request) |
| COLOUR TEMP | 3000K | 3000K (other colour temps available on request) |
| CRI | 94+ | 97+ |

DLEK935

MW

BK



WATTAGE
9W



LUMEN
946lm



IP
IP20



CRI
97+



COLOUR TEMP
3000K



BEAM ANGLE
48°

DLEK9353K

| | |
|-------------|---|
| WATTS | 9W |
| LUMEN | 946lm |
| OVERALL | 91 x 75mm |
| PROJECTION | 91mm |
| DIMMABLE | Yes |
| IP | IP20 |
| BEAM | 48° (24° & 34° available on request) |
| COLOUR TEMP | 3000K (other colour temps available on request) |
| CRI | 97+ |

DLEK936

MW

BK



WATTAGE
2x9W



LUMEN
1892lm



IP
IP20



CRI
97+



COLOUR TEMP
3000K



BEAM ANGLE
48°

| | |
|-------------|---|
| WATTS | 2 x 9W |
| LUMEN | 1892lm |
| OVERALL | 160 x 75mm |
| PROJECTION | 91mm |
| DIMMABLE | Yes |
| IP | IP20 |
| BEAM | 48° |
| COLOUR TEMP | 3000K (other colour temps available on request) |
| CRI | 97+ |

DSK601

MW

BK



WATTAGE
9W



LUMEN
1200lm



IP
IP20



CRI
97+



COLOUR TEMP
3000K



BEAM ANGLE
46°

| | |
|-------------|--------|
| WATTS | 9W |
| LUMEN | 1200lm |
| OVERALL | 93mm |
| PROJECTION | 114mm |
| DIMMABLE | Yes |
| IP | IP20 |
| BEAM | 46° |
| COLOUR TEMP | 3000K |
| CRI | 97+ |

DSK602

MW

BK















DSK603

MW

BK



| | | |
|---|--|---|
|  WATTAGE 9W |  LUMEN 1200lm |  IP IP20 |
|  CRI 97+ |  COLOUR TEMP 3000K |  BEAM ANGLE 46° |

| | | |
|---|--|---|
|  WATTAGE 2x9W |  LUMEN 2x1200lm |  IP IP20 |
|  CRI 97+ |  COLOUR TEMP 3000K |  BEAM ANGLE 46° |

| | | |
|-------------|--------|------------|
| WATTS | 9W | 2 x 9W |
| LUMEN | 1200lm | 2 x1200lm |
| OVERALL | 93mm | 186 x 93mm |
| PROJECTION | 114mm | 114mm |
| DIMMABLE | Yes | Yes |
| IP | IP20 | IP20 |
| BEAM | 46° | 46° |
| COLOUR TEMP | 3000K | 3000K |
| CRI | 97+ | 97+ |

LED DOWNLIGHTS

A complete range to suit every project and environment offering high lumen output, reliable and smooth dimming from phase dimmers or digital control.

The ability to safely cover residential downlights in the ceiling space with approved thermal insulation is an important consideration, highlighted with IC-F logo.

Many Hugo LED downlights come complete with multi selectable colour temperatures. The simple selection from the dipswitch located on the luminaire will provide 3000K, 4200K or 6500K.







The final colour temperature selection can be now made at the last minute on site minimizing stock holding and simplifying the ordering process.

DLEK751

MW

BK



| | | |
|---|--|---|
|  WATTAGE 12W |  LUMEN 900lm |  IP IP20 |
|  RECESS 117mm |  CUTOUT 92mm |  BEAM ANGLE 60° |







DLEK7513K **DLEK7514K**

| | |
|-------------|-------------|
| WATTS | 12W |
| LUMEN | 900lm |
| OVERALL | 100mm |
| CUTOUT | 92mm |
| RECESS | 117mm |
| DIMMABLE | Yes |
| RATING | IC-F |
| IP | IP20 |
| BEAM | 60° |
| COLOUR TEMP | 3000K 4000K |
| CRI | 90+ |

DLEK752

BK MW



- 
WATTAGE
2x12W
- 
LUMEN
2x900lm
- 
IP
IP20
- 
CRI
90+
- 
CUTOUT
92x192mm
- 
BEAM ANGLE
60°

DLEK7523K







DLEK7524K

| | | |
|-------------|-------------|-------|
| WATTS | 2 x 12W | |
| LUMEN | 2 x 900lm | |
| OVERALL | 100 x 200mm | |
| CUTOUT | 92 x 192mm | |
| RECESS | 117mm | |
| DIMMABLE | Yes | |
| RATING | IC-F | |
| IP | IP20 | |
| BEAM | 60° | |
| COLOUR TEMP | 3000K | 4000K |
| CRI | 90+ | |

DLEK533

BK MW









- 
WATTAGE
10.5W
- 
LUMEN
900lm
- 
IP
IP20
- 
CRI
97+
- 
CUTOUT
75mm
- 
BEAM ANGLE
45°

| | |
|-------------|-------|
| WATTS | 10.5W |
| LUMEN | 900lm |
| OVERALL | 80mm |
| CUTOUT | 75mm |
| RECESS | 85mm |
| DIMMABLE | Yes |
| RATING | IC-F |
| IP | IP20 |
| BEAM | 45° |
| COLOUR TEMP | 3000K |
| CRI | 97+ |

DLEK534

BK MW









- 
WATTAGE
10.5W
- 
LUMEN
900lm
- 
IP
IP20
- 
CRI
97+
- 
CUTOUT
75mm
- 
BEAM ANGLE
45°

| | |
|-------------|-------|
| WATTS | 10.5W |
| LUMEN | 900lm |
| OVERALL | 80mm |
| CUTOUT | 75mm |
| RECESS | 85mm |
| DIMMABLE | Yes |
| RATING | IC-F |
| IP | IP20 |
| BEAM | 45° |
| COLOUR TEMP | 3000K |
| CRI | 97+ |

DLEK536

BK MW



| | | |
|--|--|---|
|  WATTAGE 10.5W |  LUMEN 900lm |  IP IP20 |
|  CRI 97+ |  CUTOUT 75mm |  BEAM ANGLE 45° |

| | |
|-------------|-------|
| WATTS | 10.5W |
| LUMEN | 900lm |
| OVERALL | 80mm |
| CUTOUT | 75mm |
| RECESS | 85mm |
| DIMMABLE | Yes |
| RATING | IC-F |
| IP | IP20 |
| BEAM | 45° |
| COLOUR TEMP | 3000K |
| CRI | 97+ |

DLEK926

MW



| | | |
|--|--|---|
|  WATTAGE 10W |  LUMEN 900lm |  IP IP65 |
|  CRI 97+ |  CUTOUT 92mm |  FIRE RATED Yes |







DLEK9263K DLEK9264K

| | |
|-------------|------------------|
| WATTS | 10W |
| LUMEN | 900lm |
| OVERALL | 100mm |
| CUTOUT | 92mm |
| RECESS | 64mm |
| DIMMABLE | Yes |
| RATING | IC-F |
| IP | IP65 |
| BEAM | 60° |
| COLOUR TEMP | 3000K 4000K |
| CRI | 97+ |

DLEK924

MW









| | | |
|--|---|---|
|  WATTAGE 13W |  LUMEN 960lm |  IP IP44 |
|  CRI 85+ |  CUTOUT 93-95mm |  BEAM ANGLE 60° |

| | |
|-------------|-----------|
| WATTS | 13W |
| LUMEN | 960lm |
| OVERALL | 104mm |
| CUTOUT | 93 - 95mm |
| RECESS | 100mm |
| DIMMABLE | Yes |
| RATING | IC-F |
| IP | IP44 |
| BEAM | 60° |
| COLOUR TEMP | 3000K |
| CRI | 85+ |

DLEK741

MW



| | | |
|--|---|---|
|  WATTAGE 9W |  LUMEN 900lm |  IP IP20 |
|  RECESS 86mm |  CUTOUT 100mm |  BEAM ANGLE 60° |

DLEK7413K DLEK7414K

| | |
|-------------|------------------|
| WATTS | 9W |
| LUMEN | 900lm |
| OVERALL | 110mm |
| CUTOUT | 100mm |
| RECESS | 86mm |
| DIMMABLE | Yes |
| RATING | IC-F |
| IP | IP20 |
| BEAM | 60° |
| COLOUR TEMP | 3000K 4000K |
| CRI | 90+ |

DLEK731

MW

BK

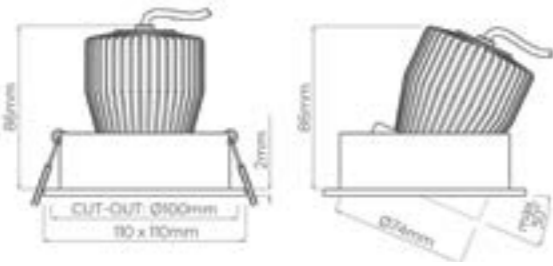

| | | |
|-------------|--------------|-------------|
| | | |
| WATTAGE | LUMEN | IP |
| 9W | 900lm | IP20 |
| | | |
| RECESS | CUTOUT | BEAM ANGLE |
| 86mm | 100mm | 60° |

DLEK7313K

DLEK7314K

| | | |
|-------------|-------|-------------------|
| WATTS | 9W | 2 x 9W |
| LUMEN | 900lm | 2 x 900lm |
| OVERALL | 110mm | 110 x 220mm |
| CUTOUT | 100mm | 100 x 210mm |
| RECESS | 86mm | 86mm |
| DIMMABLE | Yes | Yes |
| RATING | IC-F | IC-F |
| IP | IP20 | IP20 |
| BEAM | 60° | 60° |
| COLOUR TEMP | 3000K | 4000K (MW Finish) |
| CRI | 90+ | 90+ |

DLEK732

MW

BK

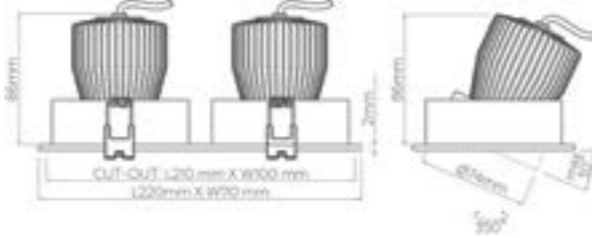

| | | |
|-------------|------------------|-------------|
| | | |
| WATTAGE | LUMEN | IP |
| 2x9W | 2x900lm | IP20 |
| | | |
| RECESS | CUTOUT | BEAM ANGLE |
| 86mm | 100x210mm | 60° |

DLEK7323K

DLEK7324K

DLEK813

MW

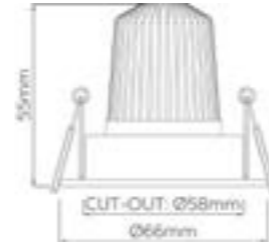

| | | |
|-------------|--------------|-------------|
| | | |
| WATTAGE | LUMEN | IP |
| 6W | 400lm | IP20 |
| | | |
| RECESS | CUTOUT | BEAM ANGLE |
| 55mm | 58mm | 36° |

DLEK372

MW

BK

BC

DLA372

MW

BC

S

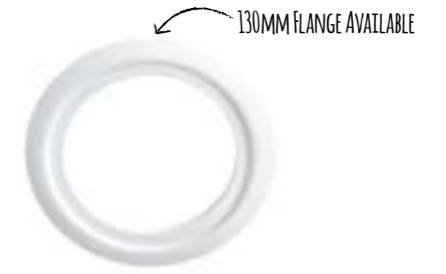

| | | |
|-------------|----------------|--------------|
| | | |
| WATTAGE | LUMEN | IP |
| 9W | 710lm | IP44 |
| | | |
| RECESS | CUTOUT | OVERALL |
| 50mm | 76-86mm | 100mm |

DLEK3723K

DLEK3724K

| | | |
|-------------|-----------|-----------|
| WATTS | 9W | 9W |
| LUMEN | 710lm | 710lm |
| OVERALL | 100mm | 100mm |
| CUTOUT | 76 - 86mm | 76 - 86mm |
| RECESS | 50mm | 50mm |
| DIMMABLE | Yes | Yes |
| RATING | IC-F | IC-F |
| IP | IP44 | IP44 |
| BEAM | 60° | 60° |
| COLOUR TEMP | 3000K | 4000K |
| CRI | 85+ | 85+ |

DLEK371

DLA372

MW

BC

S

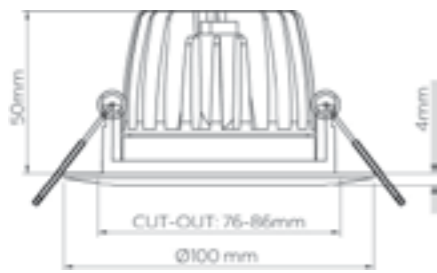

| | | |
|--------------|----------------|--------------|
| | | |
| WATTAGE | LUMEN | IP |
| 9W | 710lm | IP65 |
| | | |
| COLOUR TEMP | CUTOUT | OVERALL |
| 3000K | 76-86mm | 100mm |

DLEK220

MW

S

BC

DLA220

MW

S

BK

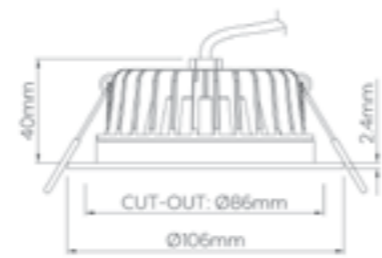

| | | |
|-------------|----------------|--------------|
| | | |
| WATTAGE | LUMEN | IP |
| 10W | 870lm | IP65 |
| | | |
| RECESS | CUTOUT | OVERALL |
| 40mm | 84-95mm | 106mm |

| | | |
|-------------|-----------|-----------|
| WATTS | 9W | 10W |
| LUMEN | 710lm | 870lm |
| OVERALL | 100mm | 106mm |
| CUTOUT | 76 - 86mm | 84 - 95mm |
| RECESS | 50mm | 40mm |
| DIMMABLE | Yes | Yes |
| RATING | IC-F | IC-F |
| IP | IP65 | IP65 |
| BEAM | 60° | 120° |
| COLOUR TEMP | 3000K | 3000K |
| CRI | 85+ | 85 - 90 |

DLEK3220

MW

BK

BC

S



FLANGE AVAILABLE - DLA3220

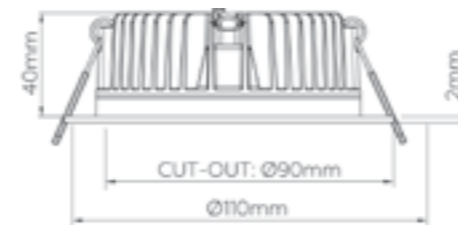

| | | |
|-------------|--------------|---------------|
| | | |
| WATTAGE | LUMEN | IP |
| 8W | 700lm | IP44 |
| | | |
| RECESS | CUTOUT | 3 CCT |
| 40mm | 90mm | 4 in 1 |

| | | |
|-------------|-------------------------|---------|
| WATTS | 8W | 6W |
| LUMEN | 700lm | 440lm |
| OVERALL | 110mm | 80mm |
| CUTOUT | 90mm | 70mm |
| RECESS | 40mm | 43mm |
| DIMMABLE | Yes | Yes |
| RATING | IC-F | IC-F |
| IP | IP44 | IP65 |
| BEAM | 90° | 120° |
| COLOUR TEMP | 2700K/3000K/4000K/6000K | 3000K |
| CRI | 85+ | 85 - 90 |

DLEK224

MW

BK



DIMMABLE

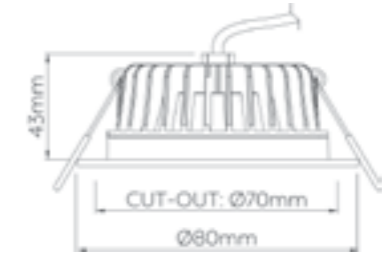

| | | |
|-------------|--------------|-------------|
| | | |
| WATTAGE | LUMEN | IP |
| 6W | 440lm | IP65 |
| | | |
| RECESS | CUTOUT | OVERALL |
| 43mm | 70mm | 80mm |

| | |
|-------------|---------|
| WATTS | 6W |
| LUMEN | 440lm |
| OVERALL | 80mm |
| CUTOUT | 70mm |
| RECESS | 43mm |
| DIMMABLE | Yes |
| RATING | IC-F |
| IP | IP65 |
| BEAM | 120° |
| COLOUR TEMP | 3000K |
| CRI | 85 - 90 |

DLEK221

MW

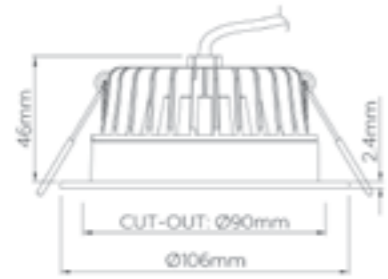

| | | |
|--------------|--------------|--------------|
| | | |
| WATTAGE | LUMEN | IP |
| 10W | 870lm | IP65 |
| | | |
| COLOUR TEMP | CUTOUT | OVERALL |
| 3000K | 90mm | 106mm |

DLEK3221

MW

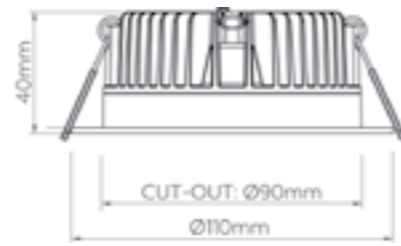

| | | |
|-------------|--------------|---------------|
| | | |
| WATTAGE | LUMEN | IP |
| 8W | 700lm | IP44 |
| | | |
| RECESS | CUTOUT | 3 CCT |
| 40mm | 90mm | 3 in 1 |

| | | |
|-------------|-------|-------------------|
| WATTS | 10W | 8W |
| LUMEN | 870lm | 700lm |
| OVERALL | 106mm | 110mm |
| CUTOUT | 90mm | 90mm |
| RECESS | 46mm | 40mm |
| DIMMABLE | Yes | Yes |
| RATING | IC-F | IC-F |
| IP | IP65 | IP44 |
| BEAM | 90° | 90° |
| COLOUR TEMP | 3000K | 3000K/4200K/6500K |
| CRI | 85+ | 85+ |

DLEK222

MW

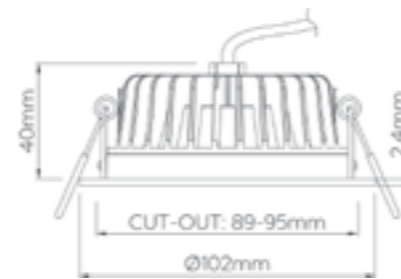

| | | |
|-------------|----------------|--------------|
| | | |
| WATTAGE | LUMEN | IP |
| 10W | 870lm | IP65 |
| | | |
| RECESS | CUTOUT | OVERALL |
| 40mm | 89-95mm | 102mm |

| | |
|-------------|-----------|
| WATTS | 10W |
| LUMEN | 870lm |
| OVERALL | 102mm |
| CUTOUT | 89 - 95mm |
| RECESS | 40mm |
| DIMMABLE | Yes |
| RATING | IC-F |
| IP | IP65 |
| BEAM | 120° |
| COLOUR TEMP | 3000K |
| CRI | 85 - 90 |

DLEK3222

MW

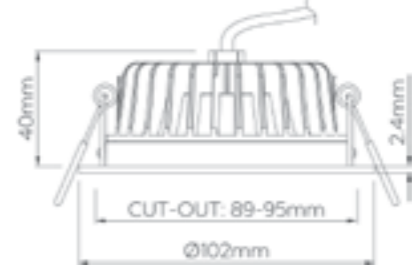

| | | |
|-------------|----------------|---------------|
| | | |
| WATTAGE | LUMEN | IP |
| 10W | 870lm | IP65 |
| | | |
| RECESS | CUTOUT | 3 CCT |
| 40mm | 89-95mm | 3 in 1 |

| | |
|-------------|-------------------|
| WATTS | 10W |
| LUMEN | 870lm |
| OVERALL | 102mm |
| CUTOUT | 89 - 95mm |
| RECESS | 40mm |
| DIMMABLE | Yes |
| RATING | IC-F |
| IP | IP65 |
| BEAM | 120° |
| COLOUR TEMP | 3000K/4200K/6500K |
| CRI | 85 - 90 |

DLEK3231

MW BC

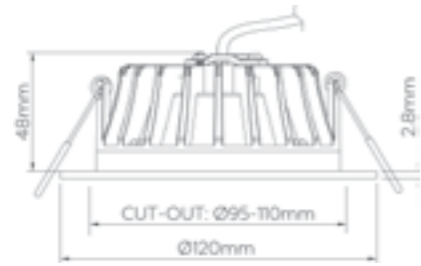

WATTAGE
12W
LUMEN
1100lm
IP
IP65
RECESS
48mm
CUTOUT
95-110mm
3 CCT
3 in 1

| | |
|-------------|-------------------|
| WATTS | 12W |
| LUMEN | 1100lm |
| OVERALL | 120mm |
| CUTOUT | 95 - 110mm |
| RECESS | 48mm |
| DIMMABLE | Yes |
| RATING | IC-F |
| IP | IP65 |
| BEAM | 110° |
| COLOUR TEMP | 3000K/4200K/6500K |
| CRI | 85 - 90 |

DLE3251

MW

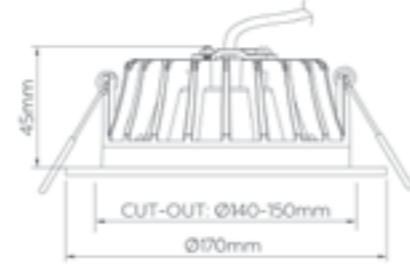

WATTAGE
18W
LUMEN
1800-2070lm
IP
IP54
RECESS
45mm
CUTOUT
140-150mm
3 CCT
3 in 1

| | |
|-------------|-------------------|
| WATTS | 18W |
| LUMEN | 1800 - 2070lm |
| OVERALL | 170mm |
| CUTOUT | 140 - 150mm |
| RECESS | 45mm |
| DIMMABLE | Yes |
| RATING | IC-4 |
| IP | IP54 |
| BEAM | 90° |
| COLOUR TEMP | 3000K/4000K/5700K |
| CRI | 80+ |

DLE3252

MW

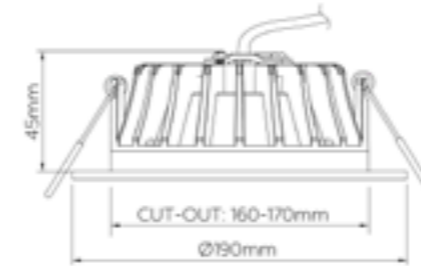

WATTAGE
25W
LUMEN
2380-2650lm
IP
IP54
RECESS
45mm
CUTOUT
160-170mm
3 CCT
3 in 1

| | |
|-------------|-------------------|
| WATTS | 25W |
| LUMEN | 2380 - 2650lm |
| OVERALL | 190mm |
| CUTOUT | 160 - 170mm |
| RECESS | 45mm |
| DIMMABLE | Yes |
| RATING | IC-4 |
| IP | IP54 |
| BEAM | 90° |
| COLOUR TEMP | 3000K/4000K/5700K |
| CRI | 80+ |

DLE3253

MW

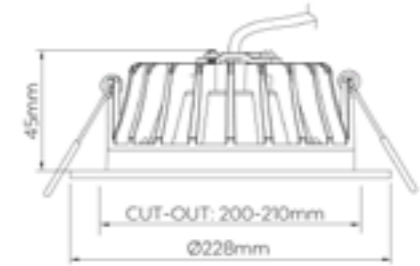

WATTAGE
35W
LUMEN
3500-4025lm
IP
IP54
RECESS
45mm
CUTOUT
200-210mm
3 CCT
3 in 1

| | |
|-------------|-------------------|
| WATTS | 35W |
| LUMEN | 3500 - 4025lm |
| OVERALL | 228mm |
| CUTOUT | 200 - 210mm |
| RECESS | 45mm |
| DIMMABLE | Yes |
| RATING | IC-4 |
| IP | IP54 |
| BEAM | 90° |
| COLOUR TEMP | 3000K/4000K/5700K |
| CRI | 80+ |

DLEK261W4

MW



DLEK240

MW



WATTAGE
40W
LUMEN
3890lm
IP
IP40
RECESS
85mm
CUTOUT
220x130mm
BEAM ANGLE
90°

WATTAGE
14W
LUMEN
1200lm
IP
IP44
RECESS
100mm
CUTOUT
115-135mm
OVERALL
145mm

| | | |
|-------------|-------------|-------------|
| WATTS | 40W | 14W |
| LUMEN | 3890lm | 1200lm |
| OVERALL | 242 x 150mm | 145mm |
| CUTOUT | 220 x 130mm | 115 - 135mm |
| RECESS | 85mm | 100mm |
| DIMMABLE | Yes | Yes |
| RATING | CA135 | IC-F |
| IP | IP40 | IP44 |
| BEAM | 90° | 90° |
| COLOUR TEMP | 4000K | 3000K |
| CRI | 85+ | 85 - 90 |

DLEK223

MW

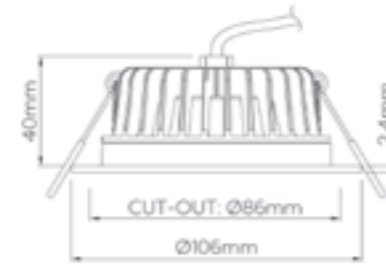

WATTAGE
13W
LUMEN
700lm
IP
IP65
RECESS
40mm
CUTOUT
86mm
SUNSET DIMMING
Yes

| | |
|-------------|---------------------------|
| WATTS | 13W |
| LUMEN | 700lm |
| OVERALL | 106mm |
| CUTOUT | 86mm |
| RECESS | 40mm |
| DIMMABLE | Yes |
| RATING | IC-F |
| IP | IP65 |
| BEAM | 120° |
| COLOUR TEMP | 2000-3000K Sunset Dimming |
| CRI | 85 - 90 |

DLEK3110

MW



WATTAGE
8W
LUMEN
830lm
IP
IP44
RECESS
60mm
CUTOUT
90-100mm
3 in 1

| | |
|-------------|-------------------|
| WATTS | 8W |
| LUMEN | 830lm |
| OVERALL | 115mm |
| CUTOUT | 90 - 100mm |
| RECESS | 60mm |
| DIMMABLE | Yes |
| RATING | IC-F |
| IP | IP44 |
| BEAM | 90° |
| COLOUR TEMP | 3000K/4200K/6500K |
| CRI | 85+ |

DLEK3125

MW

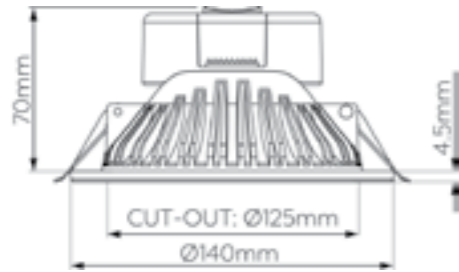

| | | |
|-------------|--------------|---------------|
| | | |
| WATTAGE | LUMEN | IP |
| 10W | 900lm | IP44 |
| | | |
| RECESS | CUTOUT | 3 CCT |
| 70mm | 125mm | 3 in 1 |

DLED812

MW



EASY INSTALLATION & WIRING



| | | |
|-------------|--------------|------------|
| | | |
| WATTAGE | LUMEN | CRI |
| 3W | 132lm | 80+ |
| | | |
| RECESS | CUTOUT | BEAM ANGLE |
| 27mm | 41mm | 30° |

| | | |
|-------------|-------------------|----------------------|
| WATTS | 10W | 3W (Driver Included) |
| LUMEN | 900lm | 132lm |
| OVERALL | 140mm | 51mm |
| CUTOUT | 125mm | 41mm |
| RECESS | 70mm | 27mm |
| DIMMABLE | Yes | No |
| RATING | IC-F | IC-F |
| IP | IP44 | IP20 |
| BEAM | 90° | 30° |
| COLOUR TEMP | 3000K/4200K/6500K | 3000K |
| CRI | 85+ | 85+ |

CB104

MW



CAN BE SURFACE MOUNTED OR RECESSED



| | | |
|-------------|-------------|--------------|
| | | |
| WATTAGE | CUTOUT | IP |
| 3W | 52mm | IP20 |
| | | |
| RECESS | OVERALL | COLOUR TEMP |
| 15mm | 65mm | 3000K |

CB303

MW

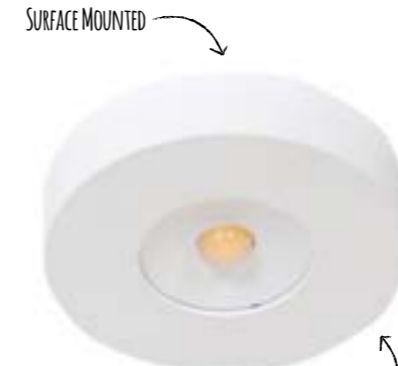

AC LED







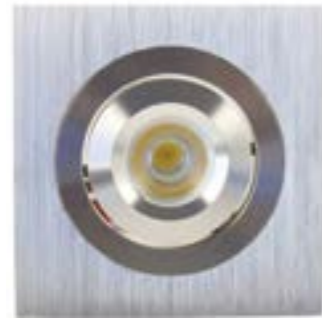

| | | |
|----------------|--------------|-------------|
| | | |
| WATTAGE | LUMEN | IP |
| 3.3W | 239lm | IP20 |
| | | |
| VOLTAGE | OVERALL | BEAM ANGLE |
| 230V AC | 63mm | 130° |

| | | |
|-------------|-----------------|-------|
| WATTS | 3.3W (230V AC) | 3W |
| LUMEN | 239lm | 220lm |
| OVERALL | 63mm | 65mm |
| CUTOUT | Surface Mounted | 52mm |
| RECESS | - | 15mm |
| DIMMABLE | No | No |
| RATING | - | - |
| IP | IP20 | IP20 |
| BEAM | 130° | - |
| COLOUR TEMP | 3000K | 3000K |
| CRI | 80+ | 80+ |

DLED611WW

AL









| | | |
|--|--|--|
|  WATTAGE 1W |  LUMEN 100lm |  IP IP20 |
|  RECESS 28mm |  CUTOUT 50mm |  COLOUR TEMP 3000K |

DLED613WW

AL



| | | |
|---|--|--|
|  WATTAGE 3x1W |  LUMEN 3x100lm |  IP IP20 |
|  RECESS 28mm |  CUTOUT 50x154mm |  COLOUR TEMP 3000K |

| | | |
|-------------|-------|------------|
| WATTS | 1W | 3 x 1W |
| LUMEN | 100lm | 3 x 100lm |
| OVERALL | 60mm | 60 x 162mm |
| CUTOUT | 50mm | 50 x 154mm |
| RECESS | 28mm | 28mm |
| DIMMABLE | No | No |
| RATING | - | - |
| IP | IP20 | IP20 |
| BEAM | 30° | 30° |
| COLOUR TEMP | 3000K | 3000K |
| CRI | - | - |

INDOOR WALL LIGHTS

Form and function are important considerations when selecting a wall fixture. The form must compliment the space, either as a feature in itself or be recessed and unobtrusive. The function will be determined on whether the luminaire is lighting an area, an object, or just a space.





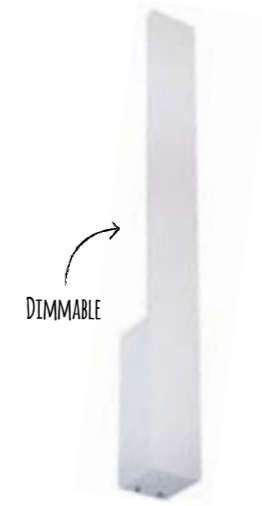

These are all important elements in the design selection process, as is the light source, power consumption, colour rendering, lighting distribution and if it can be dimmed to create further ambience.

SWL042

MW

BK



| | | |
|---|--|--|
|  WATTAGE 4.2W |  LUMEN 593lm |  IP IP20 |
|  OVERALL 425x44mm |  CRI 90+ |  PROJECTION 44mm |

| | |
|-------------|------------|
| WATTS | 4.2W |
| LUMEN | 593lm |
| OVERALL | 425 x 44mm |
| PROJECTION | 44mm |
| INPUT | 230V |
| DIMMABLE | Yes |
| IP | IP20 |
| COLOUR TEMP | 3000K |
| CRI | 90+ |

BK MW SWL044

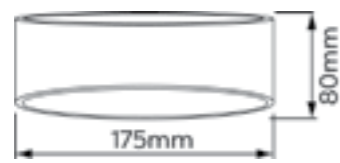

WATTAGE
5.5W
OVERALL
80x175mm

LUMEN
400lm
CRI
90+

IP
IP20
PROJECTION
90mm

| | |
|-------------|------------|
| WATTS | 5.5W |
| LUMEN | 400lm |
| OVERALL | 80 x 175mm |
| PROJECTION | 90mm |
| INPUT | 230V |
| DIMMABLE | Yes |
| IP | IP20 |
| COLOUR TEMP | 3000K |
| CRI | 90+ |

BK MW SWL046

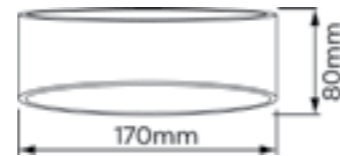

WATTAGE
5W
OVERALL
80x170mm

LUMEN
310lm
CRI
85+

IP
IP20
PROJECTION
100mm

| | |
|-------------|------------|
| WATTS | 5W |
| LUMEN | 310lm |
| OVERALL | 80 x 170mm |
| PROJECTION | 100mm |
| INPUT | 230V |
| DIMMABLE | No |
| IP | IP20 |
| COLOUR TEMP | 3000K |
| CRI | 85+ |

BK MW SWL048

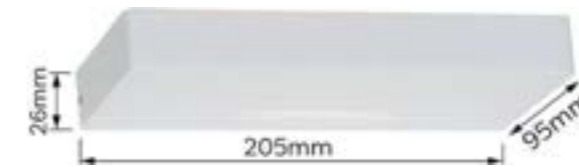
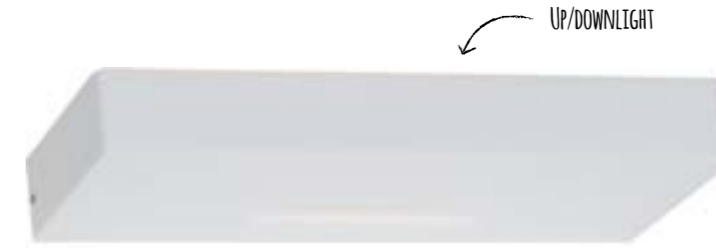

WATTAGE
2x6.2W

LUMEN
515lm

IP
IP20

OVERALL
26x205mm

CRI
80+

PROJECTION
95mm

| | |
|-------------|------------|
| WATTS | 2 x 6.2W |
| LUMEN | 515lm |
| OVERALL | 26 x 205mm |
| PROJECTION | 95mm |
| INPUT | 230V |
| DIMMABLE | Yes |
| IP | IP20 |
| COLOUR TEMP | 3000K |
| CRI | 80+ |

SWL047

MW

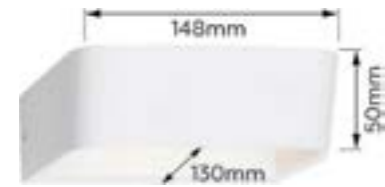
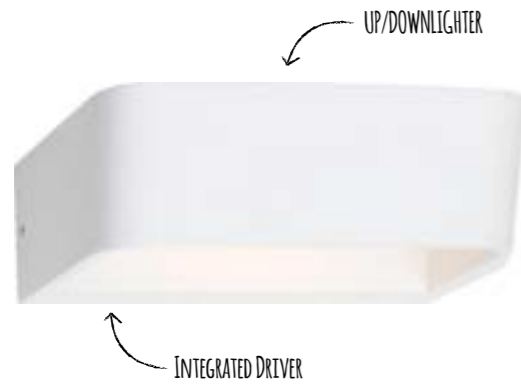

WATTAGE
3W
OVERALL
50x148mm

LUMEN
220lm
CRI
80+

IP
IP20
PROJECTION
130mm

| | |
|-------------|------------|
| WATTS | 3W |
| LUMEN | 220lm |
| OVERALL | 50 x 148mm |
| PROJECTION | 130mm |
| INPUT | 230V |
| DIMMABLE | No |
| IP | IP20 |
| COLOUR TEMP | 3000K |
| CRI | 80+ |

SWL348AC

PC

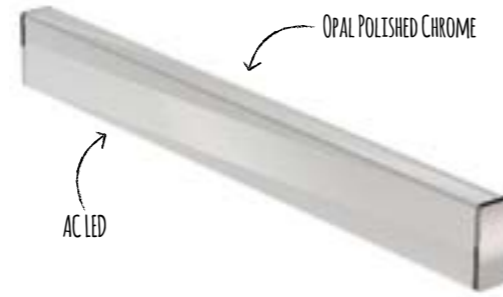

WATTAGE
12W
OVERALL
68x600mm

LUMEN
630lm
VOLTAGE
230V

IP
IP44
PROJECTION
62mm

| | |
|-------------|-------------|
| WATTS | 12W |
| LUMEN | 630lm |
| OVERALL | 68 x 600mm |
| PROJECTION | 62mm |
| INPUT | 230V AC LED |
| DIMMABLE | No |
| IP | IP44 |
| COLOUR TEMP | 3000K |
| CRI | 80+ |

SWL349AC

PC



WATTAGE
18W
OVERALL
68x900mm

LUMEN
900lm
VOLTAGE
230V

IP
IP44
PROJECTION
62mm

| | |
|-------------|-------------|
| WATTS | 18W |
| LUMEN | 900lm |
| OVERALL | 68 x 900mm |
| PROJECTION | 62mm |
| INPUT | 230V AC LED |
| DIMMABLE | No |
| IP | IP44 |
| COLOUR TEMP | 3000K |
| CRI | 80+ |

SWL336AC

PC

BK

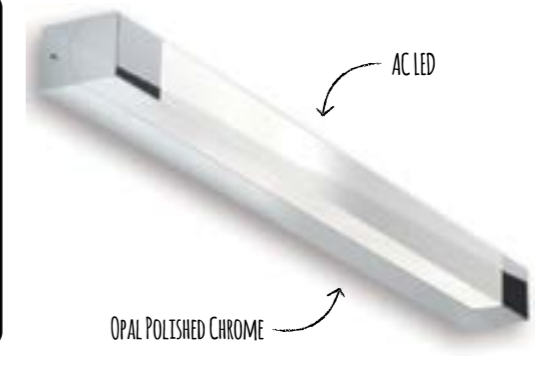

WATTAGE
12W
OVERALL
46x630mm

LUMEN
650lm
VOLTAGE
230V

IP
IP44
PROJECTION
62mm

| | |
|-------------|-------------|
| WATTS | 12W |
| LUMEN | 650lm |
| OVERALL | 46 x 630mm |
| PROJECTION | 62mm |
| INPUT | 230V AC LED |
| DIMMABLE | No |
| IP | IP44 |
| COLOUR TEMP | 3000K |
| CRI | 80+ |

MARKERS

With the development of LED technology, you can now light your stairwell, stair risers and hallways with a safe and effective lighting solution.

Marker lights can operate all day and night providing sufficient light levels to guarantee a safe passage for passers by, whilst minimising power consumption.

Hugo's latest range provides 240V mains supply direct to the LED without requiring separate drivers, perfect for a quick installation from your electrical contractor.

WATTS
INPUT
OVERALL
CUTOUT
RECESS
DIMMABLE
RATING
IP
LUMEN
COLOUR TEMP
CRI

MKL364

MW

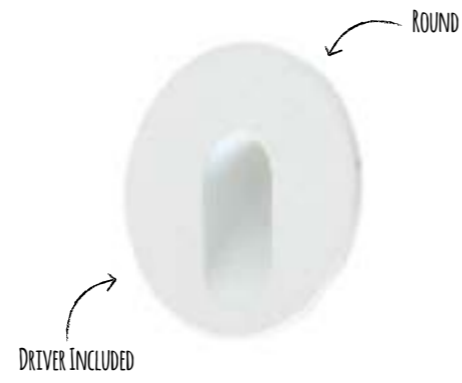

| | | |
|-------------|-------------|-------------|
| | | |
| WATTAGE | CUTOUT | IP |
| 3W | 40mm | IP20 |
| | | |
| OVERALL | VOLTAGE | RECESS |
| 44mm | 230V | 50mm |

| | |
|-------------|----------------------|
| WATTS | 3W |
| INPUT | 230V Driver Included |
| OVERALL | 44mm |
| CUTOUT | 40mm |
| RECESS | 50mm |
| DIMMABLE | No |
| RATING | IC-F |
| IP | IP20 |
| LUMEN | 132lm |
| COLOUR TEMP | 3000K |
| CRI | 85+ |

MKL365

MW



| | |
|-------------|-------------|
| | |
| WATTAGE | CUTOUT |
| 3W | 40mm |
| | |
| OVERALL | VOLTAGE |
| 45mm | 230V |
| | |
| IP | RECESS |
| IP20 | 50mm |

| | |
|-------------|----------------------|
| WATTS | 3W |
| INPUT | 230V Driver Included |
| OVERALL | 45mm |
| CUTOUT | 40mm Round |
| RECESS | 50mm |
| DIMMABLE | No |
| RATING | IC-F |
| IP | IP20 |
| LUMEN | 132lm |
| COLOUR TEMP | 3000K |
| CRI | 85+ |

MKL425

MW



| | |
|-------------|-------------|
| | |
| WATTAGE | CUTOUT |
| 4W | 57mm |
| | |
| OVERALL | VOLTAGE |
| 65mm | 230V |
| | |
| IP | RECESS |
| IP20 | 65mm |

| | |
|-------------|------------------|
| WATTS | 4W |
| INPUT | 230V AC LED Chip |
| OVERALL | 65mm |
| CUTOUT | 57mm |
| RECESS | 65mm |
| DIMMABLE | No |
| RATING | IC-F |
| IP | IP20 |
| LUMEN | 346lm |
| COLOUR TEMP | 3000K |
| CRI | 85+ |

MKL426

MW

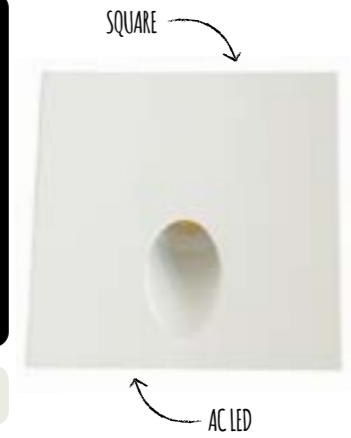

| | |
|-------------|-------------|
| | |
| WATTAGE | CUTOUT |
| 4W | 57mm |
| | |
| OVERALL | VOLTAGE |
| 65mm | 230V |
| | |
| IP | RECESS |
| IP20 | 65mm |

| | |
|-------------|------------------|
| WATTS | 4W |
| INPUT | 230V AC LED Chip |
| OVERALL | 65mm |
| CUTOUT | 57mm Round |
| RECESS | 65mm |
| DIMMABLE | No |
| RATING | IC-F |
| IP | IP20 |
| LUMEN | 346lm |
| COLOUR TEMP | 3000K |
| CRI | 85+ |

WATTS
INPUT
OVERALL
CUTOUT
RECESS
DIMMABLE
RATING
IP
LUMEN
COLOUR TEMP
CRI

OUTDOOR WALL LIGHTS

Most wall lights are now low powered LED, able to operate for extended periods at low running costs for added security around your home or project.

Hugo's outdoor wall lights come in a range of materials, including aluminum painted or plain finishes. However if you are after the optimum in exterior quality, we also offer 316 marine grade stainless steel. The range features a variety of up and down, combined, adjustable and fixed lighting in various designs.

WATTS
LUMEN
OVERALL
PROJECTION
BASE
DIMMABLE
IP
COLOUR TEMP
CRI

SWL441

BK

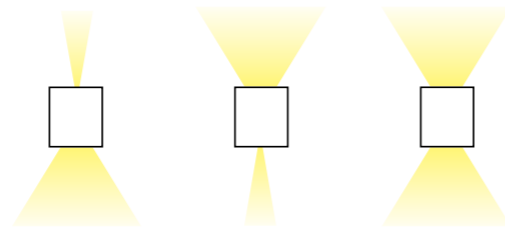
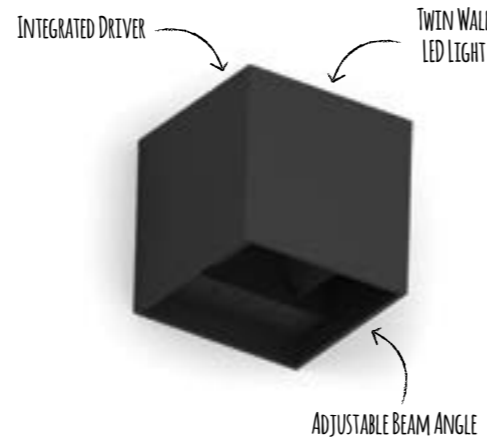

WATTAGE
5.5W



LUMEN
220lm



IP
IP65



CRI
85+



COLOUR TEMP
3000K



PROJECTION
101mm

| | |
|-------------|-------------|
| WATTS | 5.5W |
| LUMEN | 220lm |
| OVERALL | 100 x 100mm |
| PROJECTION | 101mm |
| BASE | - |
| DIMMABLE | Yes |
| IP | IP65 |
| COLOUR TEMP | 3000K |
| CRI | 85+ |

SWL443

BK

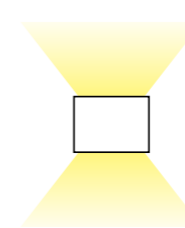
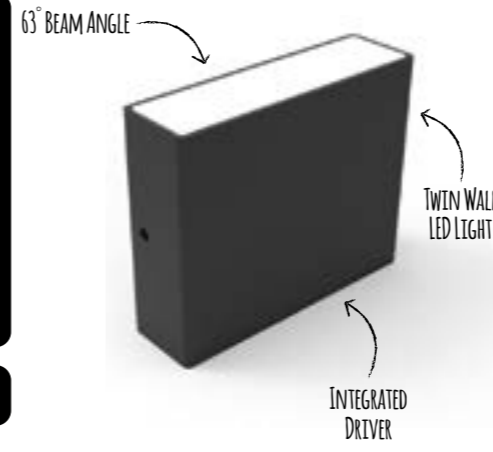

WATTAGE
7.2W



LUMEN
354lm



IP
IP65



CRI
80+



COLOUR TEMP
3000K



PROJECTION
36mm

| | |
|-------------|------------|
| WATTS | 7.2W |
| LUMEN | 354lm |
| OVERALL | 90 x 110mm |
| PROJECTION | 36mm |
| BASE | - |
| DIMMABLE | No |
| IP | IP65 |
| COLOUR TEMP | 3000K |
| CRI | 80+ |

SWL445

BK

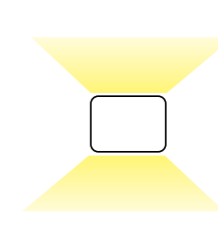
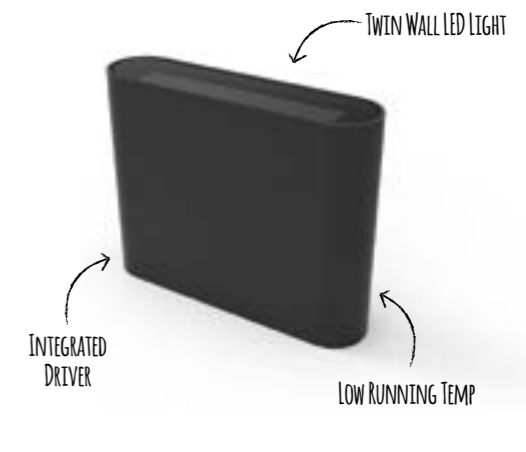

WATTAGE
6.9W



LUMEN
200lm



IP
IP54



CRI
85+



COLOUR TEMP
3000K



PROJECTION
28mm

| | |
|-------------|------------|
| WATTS | 6.9W |
| LUMEN | 200lm |
| OVERALL | 90 x 115mm |
| PROJECTION | 28mm |
| BASE | - |
| DIMMABLE | No |
| IP | IP54 |
| COLOUR TEMP | 3000K |
| CRI | 85+ |

WATTS
LUMEN
OVERALL
PROJECTION
BASE
DIMMABLE
IP
COLOUR TEMP
CRI

SWL447

BK

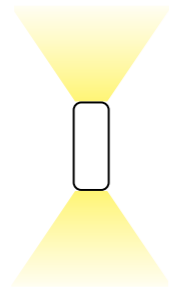

| | | |
|-------------|--------------|-------------|
| WATTAGE | LUMEN | IP |
| 5.4W | 161lm | IP65 |
| CRI | BEAM ANGLE | PROJECTION |
| 85+ | 15° | 61mm |

| | |
|-------------|------------|
| WATTS | 5.4W |
| LUMEN | 161lm |
| OVERALL | 100 x 38mm |
| PROJECTION | 61mm |
| BASE | - |
| DIMMABLE | No |
| IP | IP65 |
| COLOUR TEMP | 3000K |
| CRI | 85+ |

SWL245

MW

BK

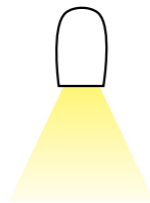

| | | |
|------------|--------------|--------------|
| WATTAGE | LUMEN | COLOUR TEMP |
| 12W | 609lm | 3000K |
| CRI | BEAM ANGLE | PROJECTION |
| 85+ | 60° | 138mm |

| | |
|-------------|------------|
| WATTS | 12W AC LED |
| LUMEN | 609lm |
| OVERALL | 110 x 70mm |
| PROJECTION | 138mm |
| BASE | 70 x 70mm |
| DIMMABLE | No |
| IP | IP65 |
| COLOUR TEMP | 3000K |
| CRI | 85+ |

SWL244

MW

BK

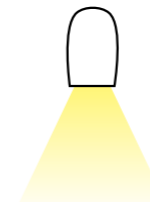

| | | |
|------------|--------------|--------------|
| WATTAGE | LUMEN | COLOUR TEMP |
| 7W | 390lm | 3000K |
| CRI | BEAM ANGLE | PROJECTION |
| 85+ | 60° | 120mm |

| | |
|-------------|-----------|
| WATTS | 7W AC LED |
| LUMEN | 390lm |
| OVERALL | 90 x 65mm |
| PROJECTION | 120mm |
| BASE | 65 x 65mm |
| DIMMABLE | No |
| IP | IP65 |
| COLOUR TEMP | 3000K |
| CRI | 85+ |

SWL242

MW

BK

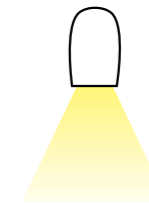

| | | |
|-------------|--------------|--------------|
| WATTAGE | LUMEN | COLOUR TEMP |
| 2.4W | 130lm | 3000K |
| CRI | VOLTAGE | PROJECTION |
| 85+ | 700mA | 74mm |

| | |
|-------------|------------------|
| WATTS | 2.4W 700mA |
| LUMEN | 130lm |
| OVERALL | 60 x 40mm |
| PROJECTION | 74mm |
| BASE | 40 x 40mm |
| DIMMABLE | Driver dependent |
| IP | IP65 |
| COLOUR TEMP | 3000K |
| CRI | 85+ |

SWL415

DG

BK

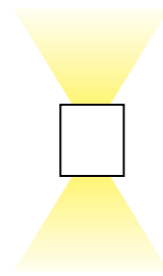
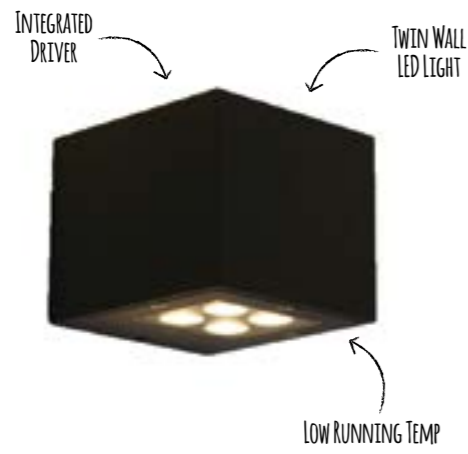

WATTAGE
8x1.2W

LUMEN
768lm

IP
IP65

CRI
85+

COLOUR TEMP
3000K

PROJECTION
103mm

SWL414

DG

BK

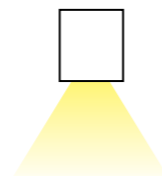

WATTAGE
4x1.2W

LUMEN
362lm

IP
IP65

CRI
85+

COLOUR TEMP
3000K

PROJECTION
103mm

| | | |
|-------------|-----------|-----------|
| WATTS | 8 x 1.2W | 4 x 1.2W |
| LUMEN | 768lm | 362lm |
| OVERALL | 82 x 93mm | 82 x 93mm |
| PROJECTION | 103mm | 103mm |
| BASE | - | - |
| DIMMABLE | No | No |
| IP | IP65 | IP65 |
| COLOUR TEMP | 3000K | 3000K |
| CRI | 85+ | 85+ |

SWL412

DG

S

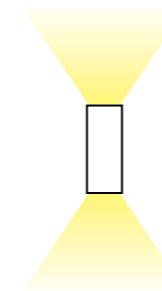

WATTAGE
2x5W

LUMEN
505lm

IP
IP65

OVERALL
184x63mm

BASE
60x60mm

PROJECTION
102mm

| | | |
|-------------|------------|------------|
| WATTS | 2 x 5W | 5W |
| LUMEN | 505lm | 244lm |
| OVERALL | 184 x 63mm | 131 x 63mm |
| PROJECTION | 102mm | 102mm |
| BASE | 60 x 60mm | 60 x 60mm |
| DIMMABLE | No | No |
| IP | IP65 | IP65 |
| COLOUR TEMP | 3000K | 3000K |
| CRI | 85+ | 85+ |

SWL411

DG

S

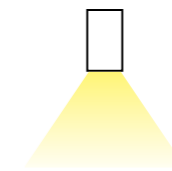
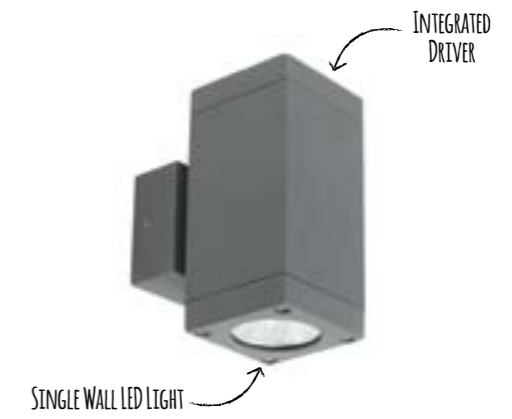

WATTAGE
5W

LUMEN
244lm

IP
IP65

CRI
85+

BASE
60x60mm

PROJECTION
102mm

SWL402

S

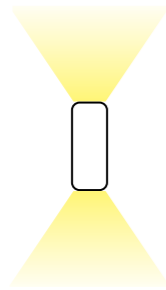

WATTAGE
2x5W

LUMEN
505lm

IP
IP65

CRI
85+

BASE
60mm

PROJECTION
102mm

SWL401

S

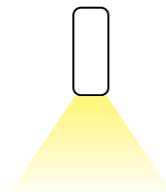

WATTAGE
5W

LUMEN
244lm

IP
IP65

CRI
85+

BASE
60mm

PROJECTION
102mm

| | | |
|-------------|------------|------------|
| WATTS | 2 x 5W | 5W |
| LUMEN | 505lm | 244lm |
| OVERALL | 184 x 65mm | 132 x 65mm |
| PROJECTION | 102mm | 102mm |
| BASE | 60 x 60mm | 60 x 60mm |
| DIMMABLE | No | No |
| IP | IP65 | IP65 |
| COLOUR TEMP | 3000K | 3000K |
| CRI | 85+ | 85+ |

SWL423

DG MW

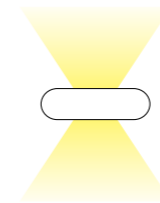

WATTAGE
6.5W

LUMEN
515lm

COLOUR TEMP
3000K

CRI
85+

IP
IP65

PROJECTION
160mm

| | |
|-------------|------------|
| WATTS | 6.5W |
| LUMEN | 515lm |
| OVERALL | 42 x 150mm |
| PROJECTION | 160mm |
| BASE | 61 x 41mm |
| DIMMABLE | No |
| IP | IP65 |
| COLOUR TEMP | 3000K |
| CRI | 85+ |

SWL522

SS

SCREW ON ATTACHMENTS

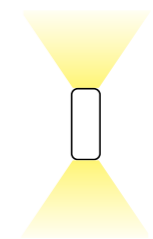
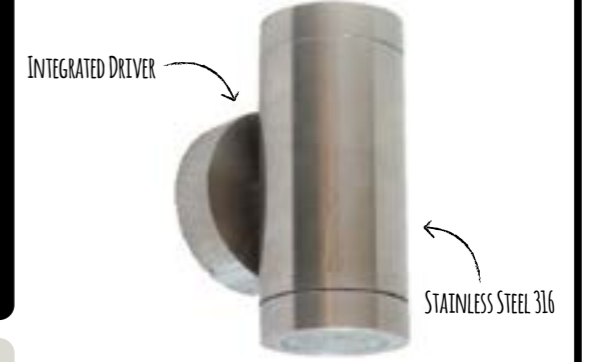

WATTAGE
2x4W

IP
IP54

COLOUR TEMP
3000K

OVERALL
140x62mm

BASE
62mm

PROJECTION
95mm

| | |
|-------------|------------|
| WATTS | 2 x 4W |
| LUMEN | - |
| OVERALL | 140 x 62mm |
| PROJECTION | 95mm |
| BASE | 62mm |
| DIMMABLE | No |
| IP | IP54 |
| COLOUR TEMP | 3000K |
| CRI | - |

SWL523

SS

SCREW ON ATTACHMENTS

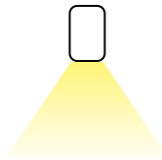

WATTAGE
4W
COLOUR TEMP
3000K
IP
IP54
OVERALL
110x62mm
BASE
62mm
PROJECTION
93mm

SWL202

SS

BK

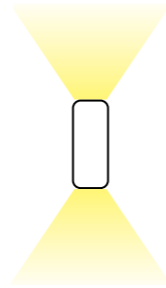

WATTAGE
2x4W
COLOUR TEMP
3000K
IP
IP54
CRI
82+
BASE
102x42mm
PROJECTION
116mm

SWL102

SS

BK

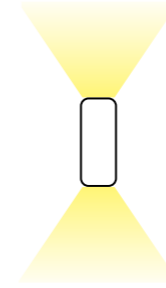

WATTAGE
2x35W
LAMP
GU10
IP
IP54
OVERALL
170x63mm
BASE
102x42mm
PROJECTION
117mm

SWL101

SS

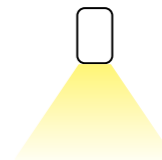
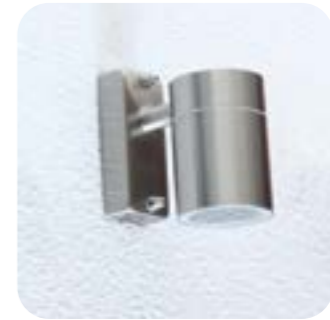

WATTAGE
35W
LAMP
GU10
IP
IP54
OVERALL
115x63mm
BASE
102x42mm
PROJECTION
117mm

| | | |
|-------------|------------|------------|
| WATTS | 4W | 2 x 4W |
| LUMEN | - | - |
| OVERALL | 110 x 62mm | 170 x 63mm |
| PROJECTION | 93mm | 116mm |
| BASE | 62mm | 102 x 42mm |
| DIMMABLE | No | No |
| IP | IP54 | IP54 |
| COLOUR TEMP | 3000K | 3000K |

| | | |
|-------------|---------------------|---------------------|
| WATTS | 2 x 35W | 35W |
| LAMP | GU10 (not included) | GU10 (not included) |
| OVERALL | 170 x 63mm | 115 x 63mm |
| PROJECTION | 117mm | 117mm |
| BASE | 102 x 42mm | 102 x 42mm |
| DIMMABLE | Yes | Yes |
| IP | IP54 | IP54 |
| COLOUR TEMP | - | - |

SWL803

AL

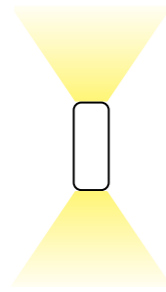
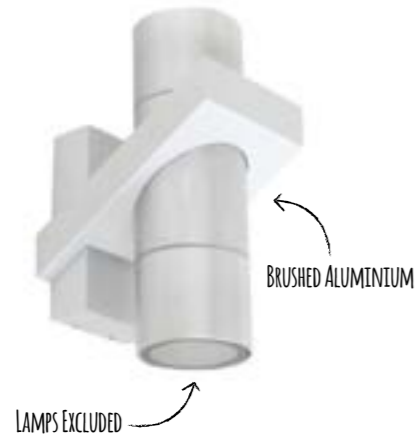

WATTAGE
2x35W

LAMP
GU10

IP
IP54

OVERALL
175x78mm

BASE
56x100mm

PROJECTION
109mm

BKH631

S

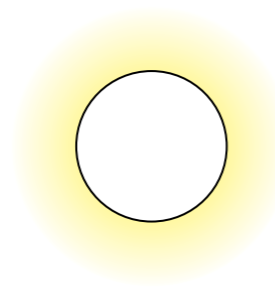

WATTAGE
20W

LUMEN
1400lm

IP
IP54

OVERALL
300mm

VOLTAGE
230V

PROJECTION
85mm

BKH634

S



WATTAGE
9W

LUMEN
560lm

IP
IP54

OVERALL
280x185mm

VOLTAGE
230V

PROJECTION
90mm

BKH1313/1314

W

BK



WATTAGE
6W

LUMEN
560lm

IP
IP54

OVERALL
168x90mm

BEAM ANGLE
120°

PROJECTION
44mm

BKH1313

BKH1314

| | | |
|-------------|------------|--------|
| WATTS | 2 x 35W | 20W |
| LUMEN | - | 1400lm |
| OVERALL | 175 x 78mm | 300mm |
| PROJECTION | 109mm | 85mm |
| BASE | 56 x 100mm | - |
| DIMMABLE | Yes | No |
| IP | IP54 | IP54 |
| COLOUR TEMP | - | 3000K |
| CRI | - | 80+ |

| | |
|-------------|-------------|
| WATTS | 9W |
| LUMEN | 560lm |
| OVERALL | 280 x 185mm |
| PROJECTION | 90mm |
| BASE | - |
| DIMMABLE | No |
| IP | IP54 |
| COLOUR TEMP | 3000K |
| CRI | 80+ |

| | |
|-------------|------------------|
| WATTS | 6W |
| LUMEN | 560lm |
| OVERALL | 168 x 90mm |
| PROJECTION | 44mm |
| BASE | - |
| DIMMABLE | No |
| IP | IP54 |
| COLOUR TEMP | 3000K 4000K |
| CRI | 80+ |

BKH111

W BK



| | | |
|------------------------------------|-------------------------------|----------------------------------|
| | | |
| WATTAGE 7W | LUMEN 520lm | IP IP54 |
| | | |
| OVERALL 205x120mm | VOLTAGE 230V | PROJECTION 95mm |

| | |
|-------------|-------------|
| WATTS | 7W |
| LUMEN | 520lm |
| OVERALL | 205 x 120mm |
| PROJECTION | 95mm |
| BASE | - |
| DIMMABLE | No |
| IP | IP54 |
| COLOUR TEMP | 3000K |
| CRI | 80+ |

RWL322

W BK

S

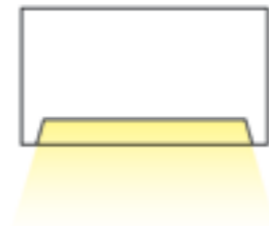
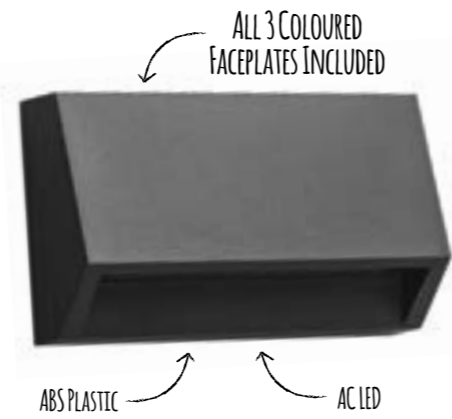

| | | |
|-----------------------------------|-------------------------------|----------------------------------|
| | | |
| WATTAGE 3W | LUMEN 160lm | IP IP65 |
| | | |
| OVERALL 70x160mm | VOLTAGE 230V | PROJECTION 33mm |

| | |
|-------------|-------------|
| WATTS | 3W |
| LUMEN | 160lm |
| OVERALL | 70 x 160 mm |
| PROJECTION | 33mm |
| BASE | - |
| DIMMABLE | No |
| IP | IP65 |
| COLOUR TEMP | 3000K |
| CRI | 84+ |

RWL321

W BK

S

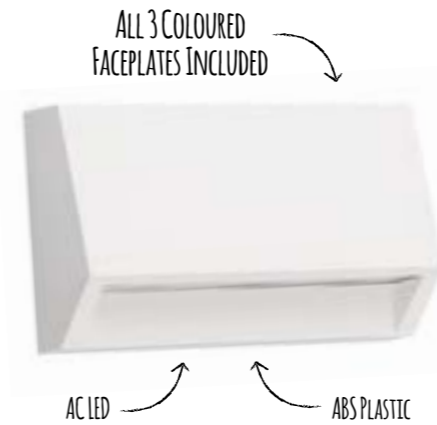

| | | |
|-----------------------------------|-------------------------------|----------------------------------|
| | | |
| WATTAGE 1.5W | LUMEN 100lm | IP IP65 |
| | | |
| OVERALL 60x100mm | VOLTAGE 230V | PROJECTION 33mm |

| | |
|-------------|-----------------|
| WATTS | 1.5W |
| LUMEN | 100lm |
| OVERALL | 60 x 100mm |
| PROJECTION | 33mm Projection |
| BASE | - |
| DIMMABLE | No |
| IP | IP65 |
| COLOUR TEMP | 3000K |
| CRI | 84+ |

MKL421

AL

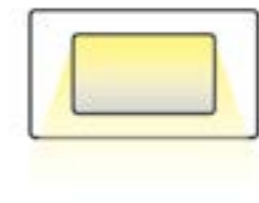
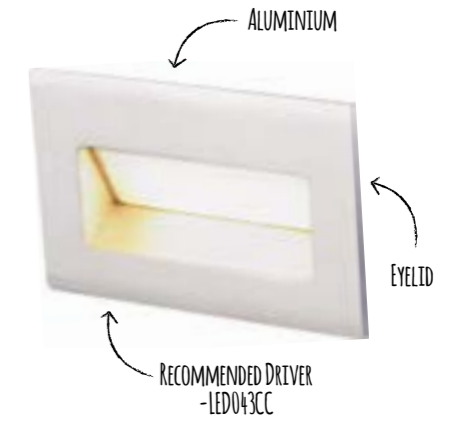

| | | |
|-----------------------------------|------------------------------------|------------------------------|
| | | |
| WATTAGE 1.2/2.4W | LUMEN 69/126lm | CRI 85+ |
| | | |
| CUTOUT 40x74mm | VOLTAGE 350/700mA | RECESS 80mm |

| | | |
|-------------|------------------|------------|
| WATTS | 1.2W 350mA | 2.4W 700mA |
| LUMEN | 69lm | 126lm |
| OVERALL | 51 x 83mm | |
| CUT-OUT | 40 x 75mm | |
| RECESS | 80mm | |
| DIMMABLE | Driver dependent | |
| IP | IP54 | |
| COLOUR TEMP | 3000K | |
| CRI | 85+ | |

MKL422

AL

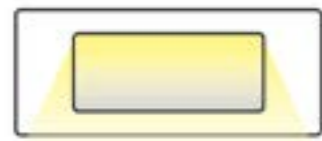
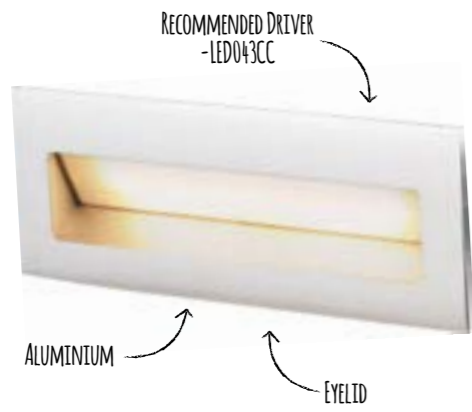

WATTAGE
1.2/2.4W

LUMEN
69/126lm

CRI
85+

CUTOUT
40x124mm

VOLTAGE
350/700mA

RECESS
80mm

MKL423

S



WATTAGE
2.7W

LUMEN
119lm

CRI
85+

CUTOUT
63x99mm

VOLTAGE
230V

RECESS
52mm

MKL424

S



WATTAGE
5.4W

LUMEN
309lm

CRI
85+

CUTOUT
63x175mm

VOLTAGE
230V

RECESS
52mm

MKL435

MW

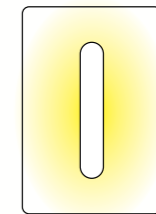
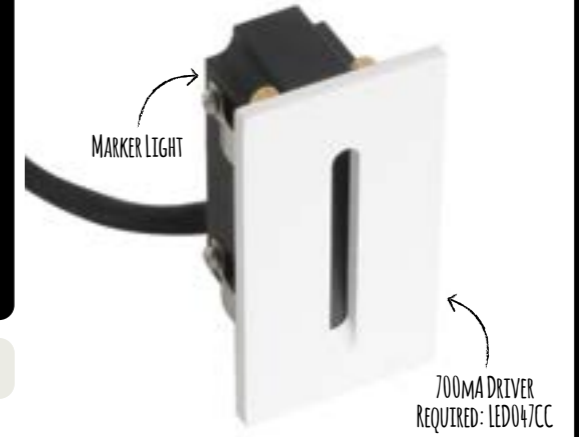

WATTAGE
2.6W

LUMEN
183lm

IP
IP65

CUTOUT
72x35mm

VOLTAGE
700mA

RECESS
45mm

| | | | |
|-------------|------------------|------------|------------|
| WATTS | 1.2W 350mA | 2.4W 700mA | 2.7W |
| LUMEN | 64lm | 126lm | 119lm |
| OVERALL | 50 x 133mm | | 85 x 110mm |
| CUT-OUT | 40 x 124mm | | 63 x 99mm |
| RECESS | 80mm | | 52mm |
| DIMMABLE | Driver dependent | | No |
| IP | IP54 | | IP65 |
| COLOUR TEMP | 3000K | | 3000K |
| CRI | 85+ | | 85+ |

| | | |
|-------------|------------|------------------|
| WATTS | 5.4W | 2.6W 700mA |
| LUMEN | 309lm | 183lm |
| OVERALL | 85 x 190mm | 43 x 80mm |
| CUT-OUT | 63 x 175mm | 72 x 35mm |
| RECESS | 52mm | 45mm |
| DIMMABLE | No | Driver dependent |
| IP | IP65 | IP65 |
| COLOUR TEMP | 3000K | 3000K & Blue |
| CRI | 85+ | 85+ |

RWL602

R

B



WATTAGE
1.2W
VOLTAGE
230V
IP
IP54
CUTOUT
112mm
LED COLOUR
2 Options
OVERALL
126mm

RWL401

CW

G

B



WATTAGE
1W
RECESS
85mm
IP
IP54
OVERALL
45x145mm
CUTOUT
39x140mm
LED COLOUR
3 Options

| | | |
|-------------|-------------|--------------------|
| WATTS | 1.2W | 1W |
| LUMEN | 183lm | - |
| OVERALL | 126 x 126mm | 45 x 145mm |
| CUT-OUT | 112mm | 39 x 140mm |
| RECESS | 65mm | 85mm |
| DIMMABLE | No | No |
| IP | IP54 | IP54 |
| COLOUR TEMP | Red, Blue | 3000K, Green, Blue |

GROUND LIGHTS

A range of in-ground and spike lights to compliment any garden landscaping. Options include square and round in-ground lights and spike lights for lighting up pathways and scrubs. A variety of finishes including high grade 316 stainless steel, different colour options from cool white, warm white through to blue, choice of input from 12V DC to 350/700mA.

GDL436

BK

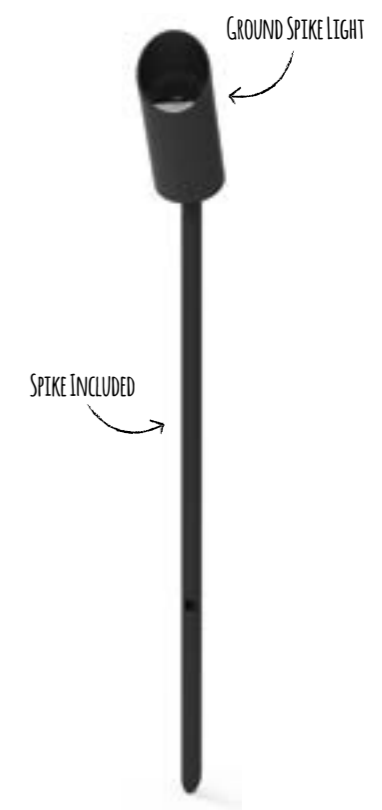

WATTAGE
6W
LUMEN
400lm
IP
IP65
OVERALL
500x45mm
VOLTAGE
12V DC
COLOUR TEMP
3000K
CRI
85+
CABLE LENGTH
1.5m
BEAM ANGLE
20.4°

| | |
|-------------|-----------------------|
| WATTS | 6W |
| LUMEN | 400lm |
| OVERALL | 500 x 45mm |
| DIMMABLE | No (driver dependent) |
| CABLE | 1.5m |
| IP | IP65 |
| BEAM | 20.4° |
| COLOUR TEMP | 3000K |
| CRI | 85+ |

GDL437



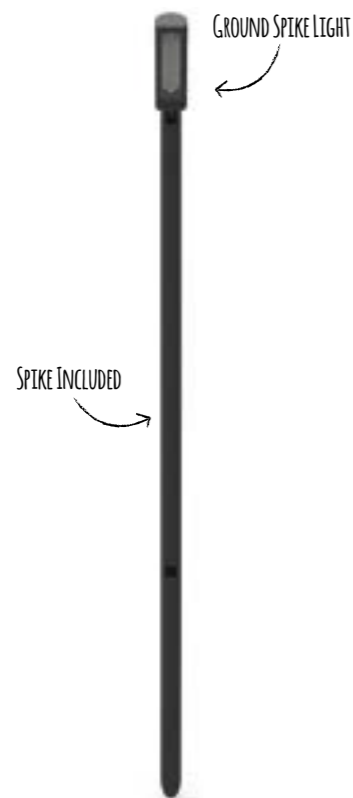





BK











GDL435

S



| | | |
|---|--|--|
|  WATTAGE 1.3W |  LUMEN 90lm |  IP IP65 |
|  OVERALL 500x20mm |  VOLTAGE 12V DC |  COLOUR TEMP 3000K |
|  CRI 85+ |  CABLE LENGTH 1.5m |  BEAM ANGLE 91° |









| | | |
|---|--|--|
|  WATTAGE 2.4W |  LUMEN 130lm |  IP IP54 |
|  OVERALL 425x37mm |  VOLTAGE 700mA |  COLOUR TEMP 3000K |
|  CRI 85+ |  CABLE LENGTH 1m |  DRIVER LED047CC |

| | | |
|-------------|-----------------------|----------------------|
| WATTS | 1.3W | 2.4W 700mA |
| LUMEN | 90lm | 130lm |
| OVERALL | 500 x 16 x 20mm | 425 x 37mm |
| CUTOUT | - | - |
| RECESS | - | - |
| DIMMABLE | No (driver dependent) | No |
| CABLE | 1.5m | 1m |
| IP | IP65 | IP54 |
| BEAM | 91° | - |
| COLOUR TEMP | 3000K | 3000K |
| CRI | 85+ | 85+ |
| DRIVER | - | LED047CC recommended |

GDL817

SS











| | | |
|---|--|--|
|  WATTAGE 8.5W |  LUMEN 687lm |  TILT ANGLE 22° |
|  VOLTAGE 230V |  CUTOUT 100mm |  RECESS 151mm |
|  MATERIAL Stainless Steel 316 |  CABLE LENGTH 1.5m |  COLOUR TEMP 3000K |

| | | |
|-------------|-------------------|-------------------|
| WATTS | 8.5W | 9W |
| LUMEN | 687lm | 473lm |
| OVERALL | 106mm | 80mm |
| CUTOUT | 100mm | 74mm |
| RECESS | 151mm | 136mm |
| DIMMABLE | No | No |
| CABLE | 1.5m | 1.5m |
| IP | IP67 | IP67 |
| BEAM | 15° | 36° |
| COLOUR TEMP | 3000K | 3000K |
| CRI | 85+ | 85+ |
| DRIVER | Integrated driver | Integrated Driver |

GDL816

SS



| | | |
|---|--|--|
|  WATTAGE 9W |  LUMEN 473lm |  BEAM ANGLE 36° |
|  OVERALL 80mm |  CUTOUT 74mm |  RECESS 136mm |
|  MATERIAL Stainless Steel 316 |  CABLE LENGTH 1.5m |  COLOUR TEMP 3000K |

GDL633

SS



GDL815

SS



GDL613

SS



GDL614

SS



 **WATTAGE**
3x1W

 **LUMEN**
75lm

 **VOLTAGE**
350mA

 **LED COLOUR**
2 Options

 **CUTOUT**
62mm

 **RECESS**
73mm

 **MATERIAL**
Stainless Steel 316

 **CABLE LENGTH**
1m

 **DRIVER**
LED043CC

 **WATTAGE**
1/3W

 **LUMEN**
70/132lm

 **VOLTAGE**
350/700mA

 **OVERALL**
39mm

 **CUTOUT**
32mm

 **RECESS**
70mm

 **MATERIAL**
Stainless Steel 316

 **CABLE LENGTH**
1m

 **DRIVER**
LED043CC / LED047CC

 **WATTAGE**
0.4W

 **LUMEN**
62lm

 **VOLTAGE**
12V DC

 **OVERALL**
28mm

 **CUTOUT**
20mm

 **RECESS**
30mm

 **MATERIAL**
Stainless Steel 316

 **CABLE LENGTH**
0.5m

 **CRI**
85+

 **WATTAGE**
0.4W

 **LUMEN**
62lm

 **VOLTAGE**
12V DC

 **OVERALL**
28mm

 **CUTOUT**
20mm

 **RECESS**
30mm

 **MATERIAL**
Stainless Steel 316

 **CABLE LENGTH**
0.5m

 **CRI**
85+

| | GDL633WW | GDL633CW | GDL815WW | GDL815CW |
|-------------|----------------------------|----------|-------------------------------|----------|
| WATTS | 3 x 1W | | 1/3W 350/750mA | |
| LUMEN | 75lm | | 70/132lm | |
| OVERALL | 90mm | | 39mm | |
| CUTOUT | 62mm | | 32mm | |
| RECESS | 73mm | | 70mm | |
| DIMMABLE | Driver dependent | | No | |
| CABLE | 1m | | 1m | |
| IP | IP54 | | IP68 | |
| BEAM | Flood | | 45° | |
| COLOUR TEMP | 3000K | 4000K | 3000K | 4000K |
| CRI | 85+ | | 85+ | |
| DRIVER | 350mA LED043CC recommended | | LED043CC/LED047CC recommended | |

| | GDL613WW | GDL613CW | GDL614WW | GDL614CW |
|-------------|---------------------|----------|---------------------|----------|
| WATTS | 0.4W | | 0.4W | |
| LUMEN | 62lm | | 62lm | |
| OVERALL | 28mm | | 28mm | |
| CUTOUT | 20mm | | 20mm | |
| RECESS | 30mm | | 30mm | |
| DIMMABLE | No | | No | |
| CABLE | 0.5m | | 0.5m | |
| IP | IP65 | | IP65 | |
| BEAM | 82° | | 82° | |
| COLOUR TEMP | 3000K | 4000K | 3000K | 4000K |
| CRI | 85+ | | 85+ | |
| DRIVER | 12V Driver required | | 12V Driver required | |

GDL615

SS



GDL616

SS



| | | |
|----------------------------|--------------|-----------------|
| | | |
| WATTAGE | LUMEN | VOLTAGE |
| 1.2W | 75lm | 350mA |
| | | |
| OVERALL | CUTOUT | RECESS |
| 25mm | 20mm | 44mm |
| | | |
| MATERIAL | CABLE LENGTH | DRIVER |
| Stainless Steel 316 | 0.5m | LED043CC |

| | | |
|----------------------------|--------------|-----------------|
| | | |
| WATTAGE | LUMEN | VOLTAGE |
| 1.2W | 75lm | 350mA |
| | | |
| OVERALL | CUTOUT | RECESS |
| 25mm | 20mm | 44mm |
| | | |
| MATERIAL | CABLE LENGTH | DRIVER |
| Stainless Steel 316 | 0.5m | LED043CC |

GDL615WW

GDL615CW

| | | |
|-------------|----------------------|-------|
| WATTS | 1.2W | 1.2W |
| LUMEN | 75lm | 75lm |
| OVERALL | 25mm | 25mm |
| CUTOUT | 20mm | 20mm |
| RECESS | 44mm | 44mm |
| DIMMABLE | No | No |
| CABLE | 0.5m | 0.5m |
| IP | IP65 | IP65 |
| BEAM | 45° | 45° |
| COLOUR TEMP | 3000K | 4000K |
| CRI | 85+ | 85+ |
| DRIVER | LED043CC recommended | |

GDL361

SS



SINGLE APERTURE



GDL362

SS

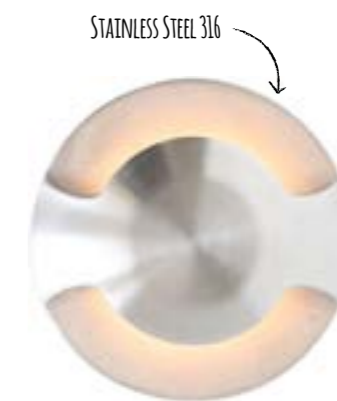

DOUBLE APERTURE

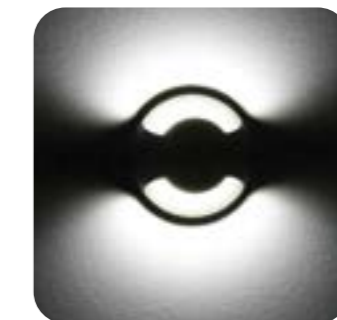

| | | |
|----------------------------|-----------------|---------------------------|
| | | |
| WATTAGE | LUMEN | VOLTAGE |
| 1/3W | 65/146lm | 350/700mA |
| | | |
| OVERALL | CUTOUT | RECESS |
| 58mm | 40mm | 50mm |
| | | |
| MATERIAL | CABLE LENGTH | DRIVER |
| Stainless Steel 316 | 0.5m | LED043CC /LED047CC |

| | | |
|----------------------------|-----------------|---------------------------|
| | | |
| WATTAGE | LUMEN | VOLTAGE |
| 1/3W | 65/146lm | 350/700mA |
| | | |
| OVERALL | CUTOUT | RECESS |
| 58mm | 40mm | 50mm |
| | | |
| MATERIAL | CABLE LENGTH | DRIVER |
| Stainless Steel 316 | 0.5m | LED043CC /LED047CC |

| | | | | |
|-------------|----------------------|----------------------|----------------------|----------------------|
| WATTS | 1W | 3W | 1W | 3W |
| LUMEN | 65lm | 146lm | 65lm | 146lm |
| OVERALL | 58mm | 58mm | 58mm | 58mm |
| CUTOUT | 40mm | 40mm | 40mm | 40mm |
| RECESS | 50mm | 50mm | 50mm | 50mm |
| DIMMABLE | No | No | No | No |
| CABLE | 0.5m | 0.5m | 0.5m | 0.5m |
| IP | IP54 | IP54 | IP54 | IP54 |
| BEAM | - | - | - | - |
| COLOUR TEMP | 3000K | 3000K | 3000K | 3000K |
| CRI | 85+ | 85+ | 85+ | 85+ |
| DRIVER | LED043CC recommended | LED047CC recommended | LED043CC recommended | LED047CC recommended |

GDL364

SS

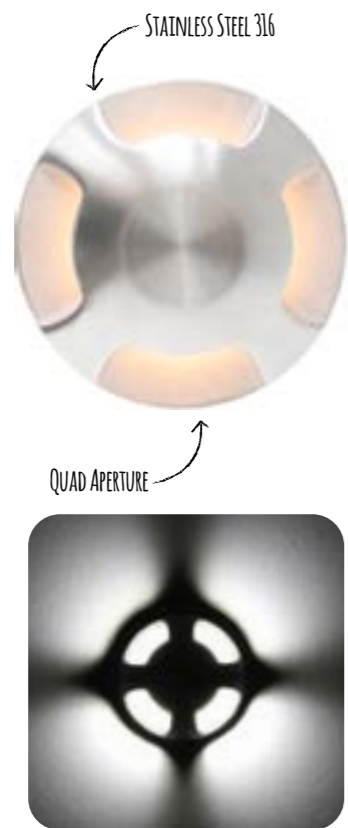

WATTAGE
1/3W
LUMEN
65/146lm
VOLTAGE
350/700mA
OVERALL
58mm
CUTOUT
40mm
RECESS
50mm
MATERIAL
Stainless Steel 316
CABLE LENGTH
0.5m
DRIVER
LED043CC /LED047CC

GDL351

SS

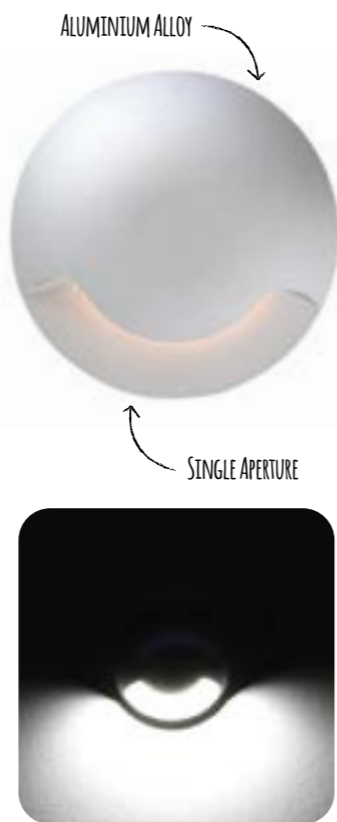

WATTAGE
1/3W
LUMEN
65/146lm
VOLTAGE
350/700mA
OVERALL
58mm
CUTOUT
40mm
RECESS
50mm
MATERIAL
Aluminium Alloy
LED COLOUR
3 Options
DRIVER
LED043CC /LED047CC

| WATTS | 1W | 3W | 1W | 3W |
|-------------|----------------------|----------------------|----------------------|----------------------|
| LUMEN | 65lm | 146lm | 65lm | 146lm |
| OVERALL | 58mm | | 58mm | |
| CUTOUT | 40mm | | 40mm | |
| RECESS | 50mm | | 50mm | |
| DIMMABLE | No | | No | |
| CABLE | 0.5m | | 0.5m | |
| IP | IP54 | | IP54 | |
| BEAM | - | | - | |
| COLOUR TEMP | 3000K | | 3000K, 4000K, Blue | |
| CRI | 85+ | | 85+ | |
| DRIVER | LED043CC recommended | LED047CC recommended | LED043CC recommended | LED047CC recommended |

GDL352

SS



WATTAGE
1/3W
LUMEN
65/146lm
VOLTAGE
350/700mA
MATERIAL
Aluminium Alloy
LED COLOUR
3 Options
CABLE LENGTH
0.5m
OVERALL
58mm
CUTOUT
40mm
RECESS
50mm
DRIVER
LED043CC /LED047CC

| 1W | 3W |
|----------------------|----------------------|
| 65lm | 146lm |
| 58mm | 58mm |
| 40mm | 40mm |
| 50mm | 50mm |
| No | No |
| 0.5m | 0.5m |
| IP54 | IP54 |
| - | - |
| 3000K, 4000K, Blue | 3000K, 4000K, Blue |
| 85+ | 85+ |
| LED043CC recommended | LED047CC recommended |

GDL353

SS

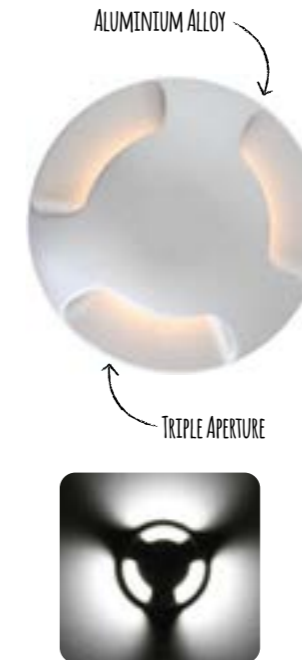

WATTAGE
1/3W
LUMEN
65/146lm
VOLTAGE
350/700mA
MATERIAL
Aluminium Alloy
LED COLOUR
3 Options
CABLE LENGTH
0.5m
OVERALL
58mm
CUTOUT
40mm
RECESS
50mm
DRIVER
LED043CC /LED047CC

| 1W | 3W |
|----------------------|----------------------|
| 65lm | 146lm |
| 58mm | 58mm |
| 40mm | 40mm |
| 50mm | 50mm |
| No | No |
| 0.5m | 0.5m |
| IP54 | IP54 |
| - | - |
| 3000K, 4000K, Blue | 3000K, 4000K, Blue |
| 85+ | 85+ |
| LED043CC recommended | LED047CC recommended |

GDL354

SS



WATTAGE
1/3W
LUMEN
65/146lm
VOLTAGE
350/700mA
MATERIAL
Aluminium Alloy
LED COLOUR
3 Options
CABLE LENGTH
0.5m
OVERALL
58mm
CUTOUT
40mm
RECESS
50mm
DRIVER
LED043CC /LED047CC

| 1W | 3W |
|----------------------|----------------------|
| 65lm | 146lm |
| 58mm | 58mm |
| 40mm | 40mm |
| 50mm | 50mm |
| No | No |
| 0.5m | 0.5m |
| IP54 | IP54 |
| - | - |
| 3000K, 4000K, Blue | 3000K, 4000K, Blue |
| 85+ | 85+ |
| LED043CC recommended | LED047CC recommended |

| WATTS | 1W | 3W |
|-------------|----------------------|----------------------|
| LUMEN | 65lm | 146lm |
| OVERALL | 58mm | |
| CUTOUT | 40mm | |
| RECESS | 50mm | |
| DIMMABLE | No | |
| CABLE | 0.5m | |
| IP | IP54 | |
| BEAM | - | |
| COLOUR TEMP | 3000K, 4000K, Blue | |
| CRI | 85+ | |
| DRIVER | LED043CC recommended | LED047CC recommended |





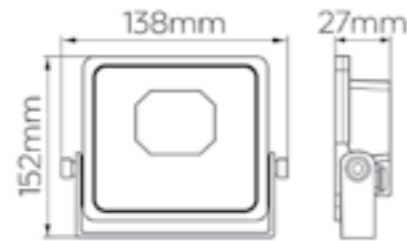
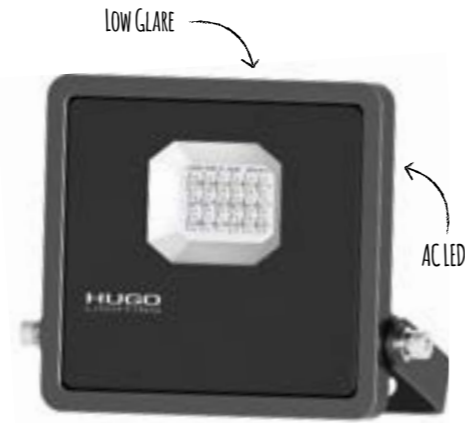

FLOODLIGHTS

Hugo's latest generation of LED floodlights utilise AC mains LED chips, avoiding the need for expensive and troublesome drivers. With their robust construction and high lumen output they are a superior replacement for halogen, metal halide and mercury vapour floodlights.

FLAC07RGB

BK







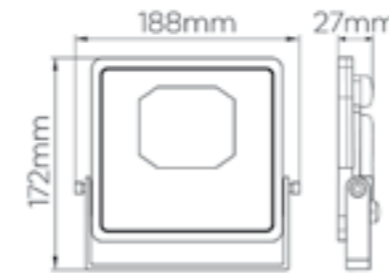
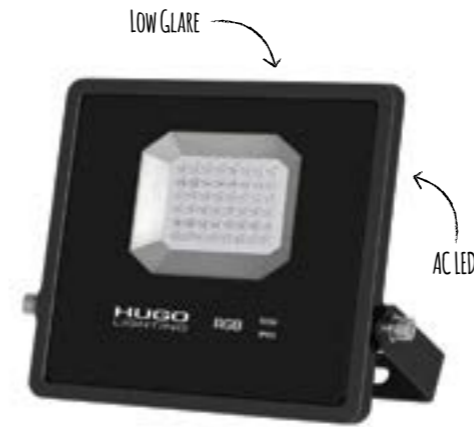

| | | |
|--|---|--|
|  WATTAGE 7W |  WEIGHT 0.5KG |  LED COLOUR RGB |
|  DIMMABLE Remote |  BEAM ANGLE 70° |  CABLE LENGTH 1.5m |

| | |
|-------------|------------------|
| WATTS | 7W |
| LUMEN | - |
| OVERALL | 152 x 138 x 27mm |
| LED QTY | 18pcs |
| WEIGHT | 0.5KG |
| DIMMABLE | Remote Control |
| IP | IP66 |
| BEAM | 70° |
| COLOUR TEMP | RGB |
| CRI | - |

FLAC015RGB

BK







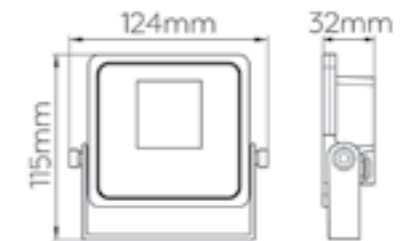

| | | |
|--|---|--|
|  WATTAGE 15W |  WEIGHT 0.4KG |  LED COLOUR RGB |
|  DIMMABLE Remote |  BEAM ANGLE 70° |  CABLE LENGTH 1.5m |

| | |
|-------------|------------------|
| WATTS | 15W |
| LUMEN | - |
| OVERALL | 172 x 188 x 27mm |
| LED QTY | 48pcs |
| WEIGHT | 0.4KG |
| DIMMABLE | Remote Control |
| IP | IP66 |
| BEAM | 70° |
| COLOUR TEMP | RGB |
| CRI | - |

FLAC10

BK



| | | |
|--|---|---|
|  WATTAGE 10W |  LUMEN 900lm |  IP IP66 |
|  COLOUR TEMP 4000K |  BEAM ANGLE 70° |  WEIGHT 0.4KG |

| | |
|-------------|------------------|
| WATTS | 10W |
| LUMEN | 900lm |
| OVERALL | 115 x 124 x 32mm |
| LED QTY | 12pcs |
| WEIGHT | 0.4KG |
| DIMMABLE | No |
| IP | IP66 |
| BEAM | 70° |
| COLOUR TEMP | 4000K |
| CRI | 80+ |

FLAC20

BK

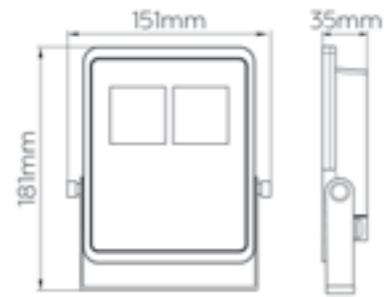

WATTAGE
20W
LUMEN
1800lm
IP
IP66
COLOUR TEMP
4000K
BEAM ANGLE
70°
WEIGHT
0.75KG

| | |
|-------------|------------------|
| WATTS | 20W |
| LUMEN | 1800lm |
| OVERALL | 181 x 151 x 35mm |
| LED QTY | 24pcs |
| WEIGHT | 0.75KG |
| DIMMABLE | No |
| IP | IP66 |
| BEAM | 70° |
| COLOUR TEMP | 4000K |
| CRI | 80+ |

FLAC50

BK

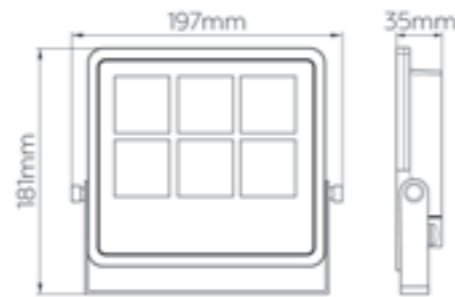

WATTAGE
50W
LUMEN
4500lm
IP
IP66
COLOUR TEMP
4000K
BEAM ANGLE
75°
WEIGHT
1KG

| | |
|-------------|------------------|
| WATTS | 50W |
| LUMEN | 4500lm |
| OVERALL | 181 x 197 x 35mm |
| LED QTY | 72pcs |
| WEIGHT | 1KG |
| DIMMABLE | No |
| IP | IP66 |
| BEAM | 75° |
| COLOUR TEMP | 4000K |
| CRI | 80+ |

FLAC100

BK

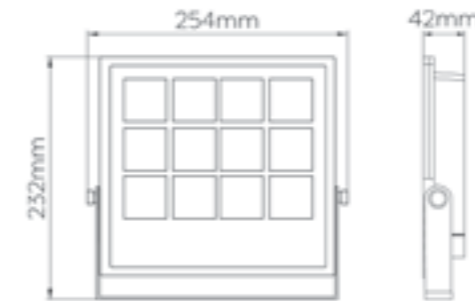

WATTAGE
100W
LUMEN
9000lm
IP
IP66
COLOUR TEMP
4000K
BEAM ANGLE
75°
WEIGHT
1.75KG

| | |
|-------------|------------------|
| WATTS | 100W |
| LUMEN | 9000lm |
| OVERALL | 232 x 254 x 42mm |
| LED QTY | 144pcs |
| WEIGHT | 1.75KG |
| DIMMABLE | No |
| IP | IP66 |
| BEAM | 75° |
| COLOUR TEMP | 4000K |
| CRI | 80+ |

FLAC200

BK

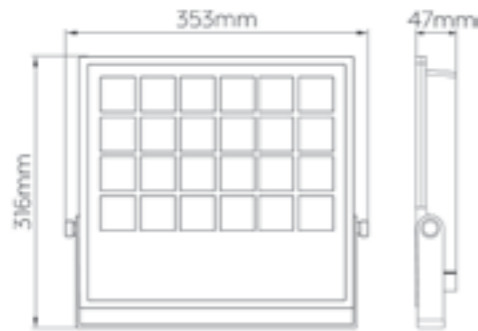

WATTAGE
200W
LUMEN
18000lm
IP
IP66
COLOUR TEMP
4000K
BEAM ANGLE
80°
WEIGHT
3.2KG

| | |
|-------------|------------------|
| WATTS | 200W |
| LUMEN | 18000lm |
| OVERALL | 316 x 353 x 47mm |
| LED QTY | 288pcs |
| WEIGHT | 3.2 KG |
| DIMMABLE | No |
| IP | IP66 |
| BEAM | 80° |
| COLOUR TEMP | 4000K |
| CRI | 80+ |

FL210

MW

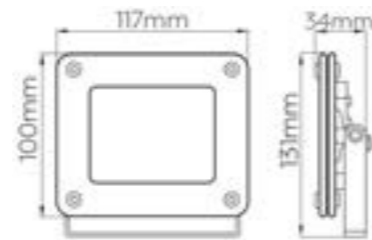
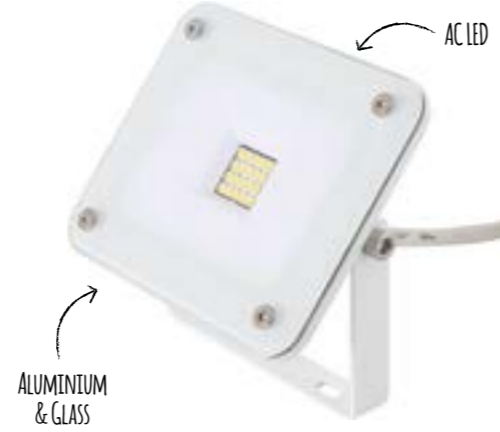

WATTAGE
10W
LUMEN
750lm
IP
IP65
OVERALL
100x117mm
VOLTAGE
230V AC
COLOUR TEMP
4000K

| | |
|-------------|------------------|
| WATTS | 10W |
| LUMEN | 750lm |
| OVERALL | 100 x 117 x 34mm |
| LED QTY | - |
| WEIGHT | - |
| DIMMABLE | No |
| IP | IP65 |
| BEAM | 90° |
| COLOUR TEMP | 4000K |
| CRI | 80+ |

FL220

MW

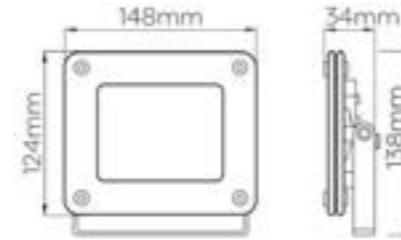
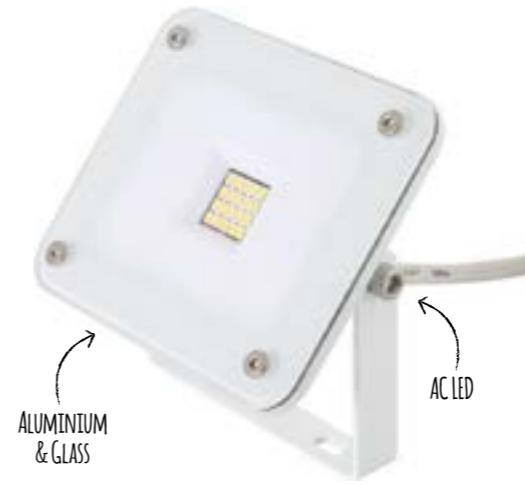

WATTAGE
18W
LUMEN
1400lm
IP
IP65
OVERALL
124x148mm
VOLTAGE
230V AC
COLOUR TEMP
4000K

| | |
|-------------|------------------|
| WATTS | 18W |
| LUMEN | 1400lm |
| OVERALL | 124 x 148 x 34mm |
| LED QTY | - |
| WEIGHT | - |
| DIMMABLE | No |
| IP | IP65 |
| BEAM | 90° |
| COLOUR TEMP | 4000K |
| CRI | 80+ |

FL050

AL

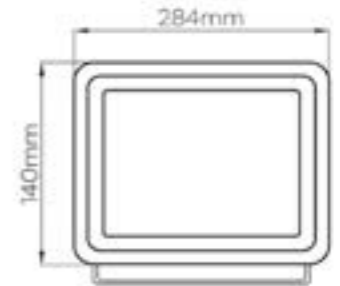

WATTAGE
50W
LUMEN
4500lm
IP
IP65
OVERALL
140x284mm
VOLTAGE
230V AC
COLOUR TEMP
6000K

| | |
|-------------|-------------------|
| WATTS | 50W |
| LUMEN | 4500lm |
| OVERALL | 140 x 284 x 260mm |
| LED QTY | - |
| WEIGHT | - |
| DIMMABLE | No |
| IP | IP65 |
| BEAM | 90° |
| COLOUR TEMP | 6000K |
| CRI | 80+ |



LED HIGHBAYS

Our new generation of high efficiency LED high bays renders traditional mercury vapour, metal halide, sodium light sources and even high efficiency T5 lamps obsolete.

Hugo high bays are designed for industrial applications in stores, factories, retail applications and warehouses. Able to instantly start with no re-strike or cooling off periods, this range is suitable for motion and occupancy sensors as well as 1-10Volt dimming or DALI controls if required.

Various options are available to suit your project - from alternative LED beam distribution to wall mounting brackets, polycarbonate lenses for food preparation areas as well as metal reflectors for improved shielding angle.

System efficiency and lumen output is extremely high coupled with long service life.

HB125LG

BK

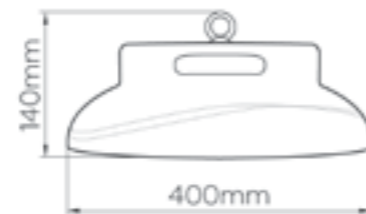





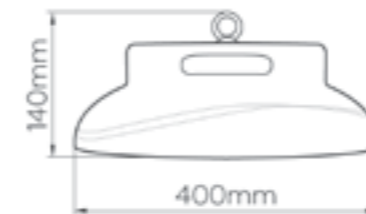

| | | |
|---|--|---|
|  WATTAGE 125W |  LUMEN 15000lm |  SENSORS Available |
|  CRI 80+ |  COLOUR TEMP 5000K |  DIMMABLE Available |

| | |
|-------------|--------------|
| WATTS | 125W |
| LUMEN | 15000lm |
| OVERALL | 140 x 400mm |
| DIMMABLE | Available |
| IP | IP65 |
| BEAM | 60° 80° 110° |
| COLOUR TEMP | 5000K |
| CRI | 80+ |
| STOCK | Indent only |

HB155LG

BK







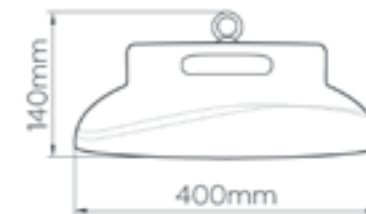

| | | |
|---|--|---|
|  WATTAGE 155W |  LUMEN 20000lm |  SENSORS Available |
|  CRI 80+ |  COLOUR TEMP 5000K |  DIMMABLE Available |

| | |
|-------------|--------------|
| WATTS | 155W |
| LUMEN | 20000lm |
| OVERALL | 140 x 400mm |
| DIMMABLE | Available |
| IP | IP65 |
| BEAM | 60° 80° 110° |
| COLOUR TEMP | 5000K |
| CRI | 80+ |
| STOCK | Indent only |

HB165LG

BK



| | | |
|---|--|---|
|  WATTAGE 165W |  LUMEN 22000lm |  SENSORS Available |
|  CRI 80+ |  COLOUR TEMP 5000K |  DIMMABLE Available |

| | |
|-------------|--------------|
| WATTS | 165W |
| LUMEN | 22000lm |
| OVERALL | 140 x 400mm |
| DIMMABLE | Available |
| IP | IP65 |
| BEAM | 60° 80° 110° |
| COLOUR TEMP | 5000K |
| CRI | 80+ |
| STOCK | Indent only |



WATTS
LUMEN
OVERALL
DIMMABLE
IP
BEAM
COLOUR TEMP
CRI
STOCK

WATTS
LUMEN
OVERALL
DIMMABLE
IP
BEAM
COLOUR TEMP
CRI
STOCK



HB100-5

BK

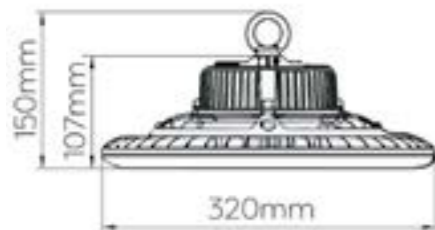
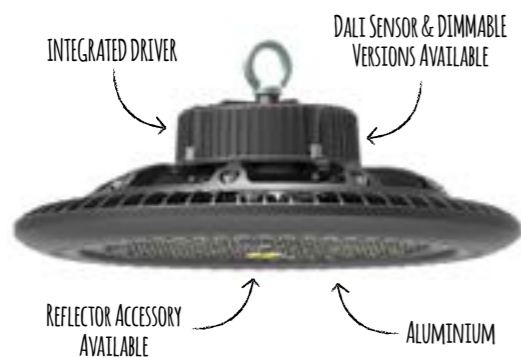

WATTAGE
100W

LUMEN
13000lm

SENSORS
Available

CRI
80+

COLOUR TEMP
5000K

DIMMABLE
Available

HB150-5

BK

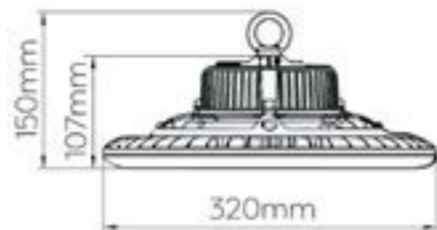

WATTAGE
150W

LUMEN
20000lm

SENSORS
Available

CRI
80+

COLOUR TEMP
5000K

DIMMABLE
Available

HB200-5

BK

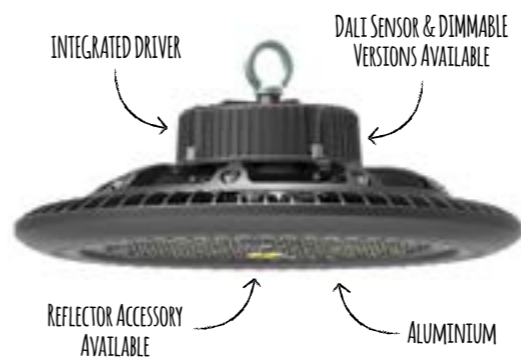

WATTAGE
200W

LUMEN
26000lm

SENSORS
Available

CRI
80+

COLOUR TEMP
5000K

DIMMABLE
Available

HBBREF



| | |
|-------------|------------------------|
| WATTS | 100W |
| LUMEN | 13000lm |
| OVERALL | 150 x 320mm |
| LED QTY | 126pcs |
| WEIGHT | 3.0KG |
| DIMMABLE | Available - DALI 1-10V |
| IP | IP65 |
| BEAM | 120° |
| COLOUR TEMP | 5000K |
| CRI | 80+ |

| | |
|-------------|------------------------|
| WATTS | 150W |
| LUMEN | 20000lm |
| OVERALL | 150 x 320mm |
| LED QTY | 182pcs |
| WEIGHT | 3.2KG |
| DIMMABLE | Available - DALI 1-10V |
| IP | IP65 |
| BEAM | 90° |
| COLOUR TEMP | 5000K |
| CRI | 80+ |

| | |
|-------------|------------------------|
| WATTS | 200W |
| LUMEN | 26000lm |
| OVERALL | 150 x 320mm |
| LED QTY | 240pcs |
| WEIGHT | 3.4KG |
| DIMMABLE | Available - DALI 1-10V |
| IP | IP65 |
| BEAM | 90° |
| COLOUR TEMP | 5000K |
| CRI | 80+ |

| | |
|-------------|--|
| WATTS | |
| LUMEN | |
| OVERALL | |
| LED QTY | |
| WEIGHT | |
| DIMMABLE | |
| IP | |
| BEAM | |
| COLOUR TEMP | |
| CRI | |



BATTENS

The traditional batten was naturally based around linear fluorescent T8 and T5 lamps and available as bare lamp versions with prismatic or opal diffusers.

Developments in SMD LED technology has enabled machines to cost effectively mount these on aluminum plates and thereby rendering the traditional batten redundant for most applications.

The perfect luminaire for your next project.

WATTS
LUMEN
OVERALL
INPUT
PROJECTION
DIMMABLE
RATING
COLOUR TEMP
CRI

BAT025/035/048/049

W



| | | |
|------------------|-------------|--------------|
| | | |
| WATTAGE | VOLTAGE | IP |
| 25/35/48W | 230V | IP20 |
| | | |
| CRI | PROJECTION | COLOUR TEMP |
| 80+ | 31mm | 4000K |

| BAT025 | BAT035 | BAT048 | BAT049 |
|-------------|-------------|--------------|--------------|
| 25W | 35W | 48W | 48W |
| 2000lm | 3100lm | 4200lm | 4700lm |
| 120 x 613mm | 120 x 913mm | 120 x 1213mm | 120 x 1500mm |
| | 230V | | |
| | 31mm | | |
| | No | | |
| | IP20 | | |
| | 4000K | | |
| | 80+ | | |

BAT1200/1500

W

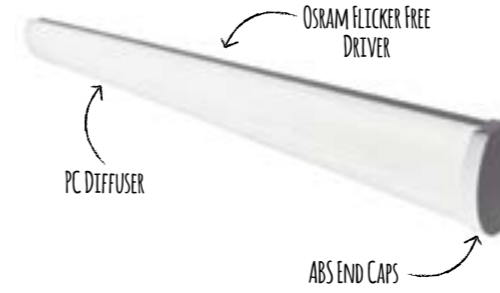

| | | |
|---------------|-------------|---------------|
| | | |
| WATTAGE | VOLTAGE | IP |
| 50/65W | 230V | IP20 |
| | | |
| CRI | PROJECTION | 3 CCT |
| 84+ | 76mm | 3 in 1 |

| BAT1200 | BAT1500 |
|--------------|-------------------|
| 50W | 65W |
| 5000lm | 6200lm |
| 126 x 1198mm | 126 x 1498mm |
| | 230V |
| | 76mm |
| | No |
| | IP20 |
| | 3000K/4000K/5000K |
| | 84+ |

BAT60

W

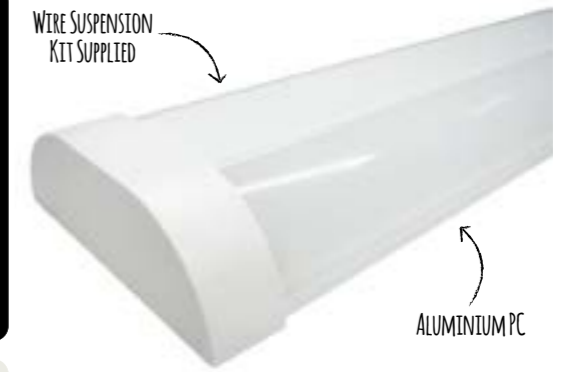

| | | |
|------------|---------------|-------------|
| | | |
| WATTAGE | LUMEN | IP |
| 55W | 5100lm | IP20 |
| | | |
| CRI | PROJECTION | VOLTAGE |
| 80+ | 40mm | 230V |

| BAT604K | BAT606K |
|---------|--------------|
| | 55W |
| | 5100lm |
| | 119 x 1510mm |
| | 230V |
| | 40mm |
| | No |
| | IP20 |
| | 4000K |
| | 6000K |
| | 80+ |



WATTS
LUMEN
OVERALL
INPUT
PROJECTION
DIMMABLE
RATING
COLOUR TEMP
CRI

UNDER VERANDAH

These low energy, enclosed linear IP65 LED under verandah luminaires are ideal for exterior and industrial areas, including car parks and stairwells.

With an impact rating of IK068 and an ingress rating of IP65, they offer extremely high lumen output at low operating costs.

WATTS
LUMEN
OVERALL
INPUT
PROJECTION
DIMMABLE
IP
COLOUR TEMP
CRI

WP11200

W

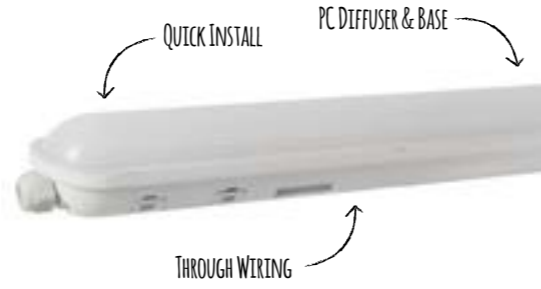

| | | |
|------------|------------------|--------------|
| | | |
| WATTAGE | LUMEN | IP |
| 40W | 5200lm | IP65 |
| | | |
| CRI | SENSORS | COLOUR TEMP |
| 80+ | Available | 4000K |

| | |
|-------------|-------------|
| WATTS | 40W |
| LUMEN | 5200lm |
| OVERALL | 72 x 1180mm |
| INPUT | 230V |
| PROJECTION | 61mm |
| DIMMABLE | No |
| IP | IP65 & IK08 |
| COLOUR TEMP | 4000K |
| CRI | 80+ |

WP11500

W

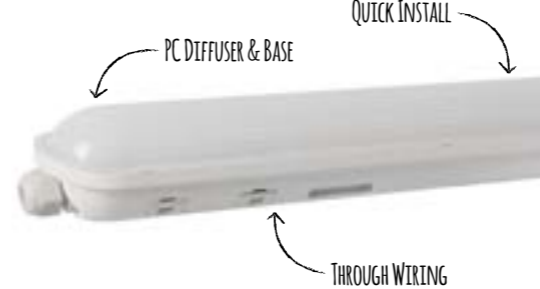

| | | |
|------------|------------------|--------------|
| | | |
| WATTAGE | LUMEN | IP |
| 55W | 7150lm | IP65 |
| | | |
| CRI | SENSORS | COLOUR TEMP |
| 80+ | Available | 4000K |

| | |
|-------------|-------------|
| WATTS | 55W |
| LUMEN | 7150lm |
| OVERALL | 72 x 1480mm |
| INPUT | 230V |
| PROJECTION | 61mm |
| DIMMABLE | No |
| IP | IP65 & IK08 |
| COLOUR TEMP | 4000K |
| CRI | 80+ |

WP21500



| | | |
|------------|------------------|---------------|
| | | |
| WATTAGE | LUMEN | IP |
| 48W | 7200lm | IP65 |
| | | |
| CRI | SENSORS | 3CCT |
| 80+ | Available | 3 in 1 |

| | |
|-------------|-------------------|
| WATTS | 48W |
| LUMEN | 7200lm |
| OVERALL | 77 x 1500mm |
| INPUT | 230V |
| PROJECTION | 66mm |
| DIMMABLE | No |
| IP | IP65 & IK08 |
| COLOUR TEMP | 4000K/5000K/6500K |
| CRI | 80+ |

CABINET

Hugo's range of small, unobtrusive, low-level lighting is perfect for underneath kitchen benches, bars and cabinets.

Utilising low wattage LED technology, these luminaires are able to provide adequate light whilst providing long service life.





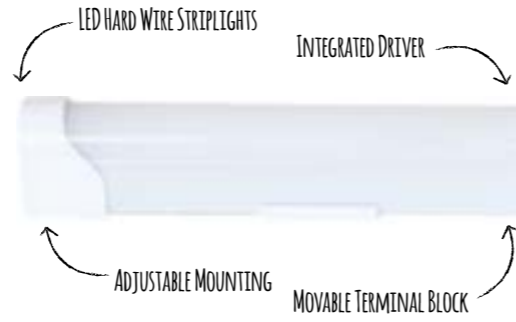

A selection of recessed and surface options, round and square, as well as linear linkable options able to be hardwired or connected to plug bases.

WATTS
LUMEN
OVERALL
INPUT
PROJECTION
DIMMABLE
IP
COLOUR TEMP

CBLED10H

W







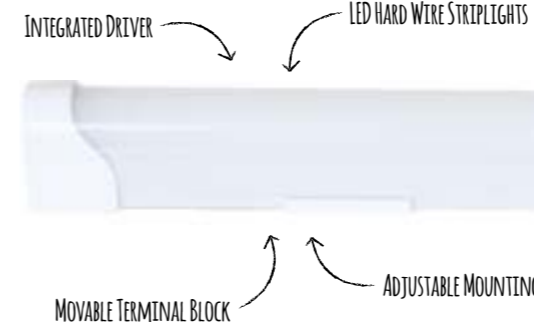

| | | |
|--|--|--|
|  WATTAGE 10W |  LUMEN 850lm |  IP IP20 |
|  CRI 80+ |  PROJECTION 44mm |  COLOUR TEMP 4200K |

| | |
|-------------|------------|
| WATTS | 10W |
| LUMEN | 850lm |
| OVERALL | 29 x 600mm |
| INPUT | 230V |
| PROJECTION | 44mm |
| DIMMABLE | No |
| IP | IP20 |
| COLOUR TEMP | 4200K |

CBLED15H

W









| | | |
|--|--|--|
|  WATTAGE 15W |  LUMEN 1300lm |  IP IP20 |
|  CRI 80+ |  PROJECTION 44mm |  COLOUR TEMP 4200K |

| | |
|-------------|------------|
| WATTS | 15W |
| LUMEN | 1300lm |
| OVERALL | 29 x 900mm |
| INPUT | 230V |
| PROJECTION | 44mm |
| DIMMABLE | No |
| IP | IP20 |
| COLOUR TEMP | 4200K |

CBLED20H

W



| | | |
|--|--|--|
|  WATTAGE 20W |  LUMEN 1700lm |  IP IP20 |
|  CRI 80+ |  PROJECTION 44mm |  COLOUR TEMP 4200K |

| | |
|-------------|-------------|
| WATTS | 20W |
| LUMEN | 1700lm |
| OVERALL | 29 x 1200mm |
| INPUT | 230V |
| PROJECTION | 44mm |
| DIMMABLE | No |
| IP | IP20 |
| COLOUR TEMP | 4200K |

WATTS
LUMEN
OVERALL
INPUT
PROJECTION
DIMMABLE
IP
COLOUR TEMP

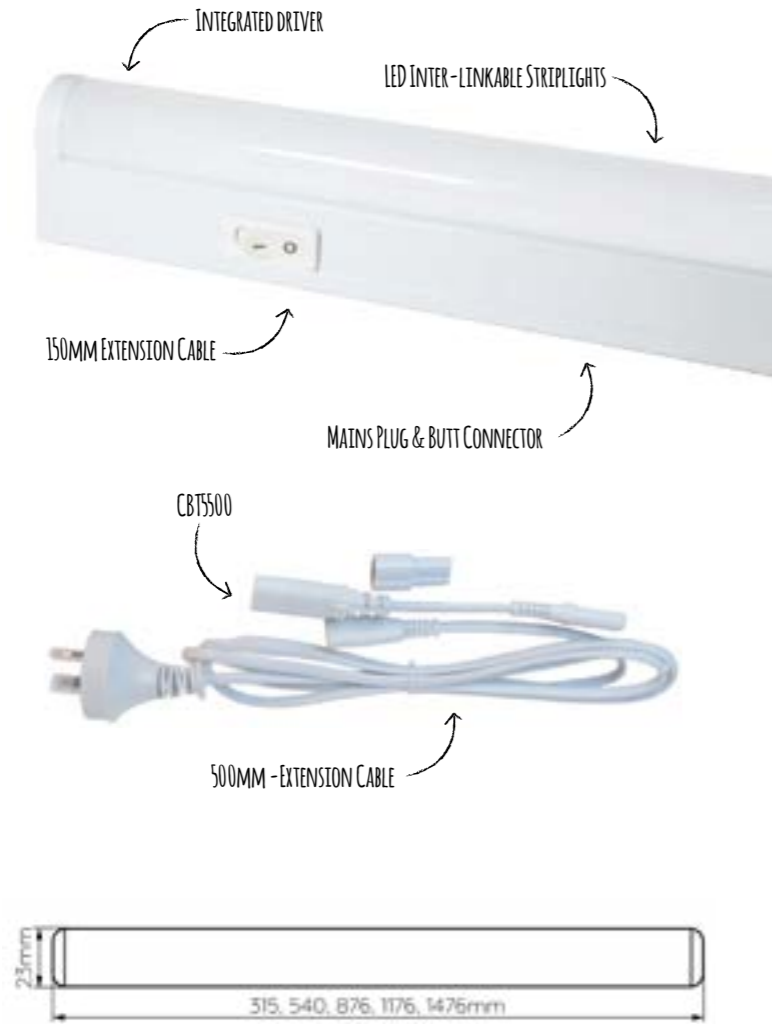

| | | | |
|--|---------------------------|-----------------------------|-------------------|
| WATTAGE 4/9/13/18/22W | VOLTAGE 230V | INTERLINKABLE Yes | IP IP20 |
| LUMEN 340/800/1150/1700/2100lm | PROJECTION 37mm | COLOUR TEMP 4200K | |

| | CBLED04 | CBLED09 | CBLED13 | CBLED18 | CBLED22 | CBT5300 | CBT5500 |
|-------------|------------|------------|------------|-------------|-------------|---------|---------|
| WATTS | 4W | 9W | 13W | 18W | 22W | | |
| LUMEN | 340lm | 800lm | 1150lm | 1700lm | 2100lm | | |
| OVERALL | 23 x 315mm | 23 x 540mm | 23 x 876mm | 23 x 1176mm | 23 x 1476mm | 300mm | 500mm |
| INPUT | 230V | | | | | | |
| PROJECTION | 37mm | | | | | | |
| DIMMABLE | No | | | | | | |
| IP | IP20 | | | | | | |
| COLOUR TEMP | 4200K | | | | | | |



SENSORS

Hugo sensors are a great way to reduce energy and Co², especially when matched with our LED luminaires. The automatic unit will not activate when natural light is sufficient and has adjustable time delay, lux control and override features. Fast and easy installation and set up.



| | |
|---------------------------------|--------------------------------|
| INSTALL HEIGHT 2.2-4m | VOLTAGE 220-240V |
| RUN TIME 5sec-5min | TEMP RANGE -20 +40° |
| IP IP44 | TIME DELAY 8sec-8min |

| |
|---------------------------|
| 220 - 240V |
| 12m <24° |
| 86 x 78 x 98mm |
| 2.2 - 4m |
| 1 - 300W |
| 1200W |
| 3-2000 Lux adj |
| 5sec - 5min |
| 0.6 - 1.5m/s |
| -20 - +40° |
| 0.45W Working 0.1W Static |
| 8sec - 8min adj |



| | |
|---------------------------------|---------------------------------|
| INSTALL HEIGHT 2.2-4m | VOLTAGE 220-240V |
| RUN TIME 5sec-5min | TEMP RANGE -20 +40° |
| IP IP44 | TIME DELAY 10sec-7min |

| |
|---------------------------|
| 220 - 240V |
| 6m <24° |
| 75 x 77mm |
| 2.2 - 4m |
| 1 - 300W |
| 1200W |
| 3-2000 Lux adj |
| 5sec - 5min |
| 0.6 - 1.5m/s |
| -20 - +40° |
| 0.45W Working 0.1W Static |
| 10sec - 7min adj |

| |
|-------------------|
| INPUT |
| RANGE |
| OVERALL |
| INSTALL HEIGHT |
| LED RATED LOAD |
| OTHER RATED LOAD |
| AMBIENT LIGHT |
| RUN TIME |
| MOTION SPEED |
| TEMP RANGE |
| POWER CONSUMPTION |
| TIME DELAY |

LED PANELS

Hugo's commercial panels feature side illuminated LEDs which provide even and efficient illumination over the entire opal panel surface. They are designed to fit perfectly inside T-bar ceiling rails for a clean

architectural appearance, whilst also offering optimum lumen output at a low wattage. With the appropriate kit they can also be plaster or surface mounted if required.

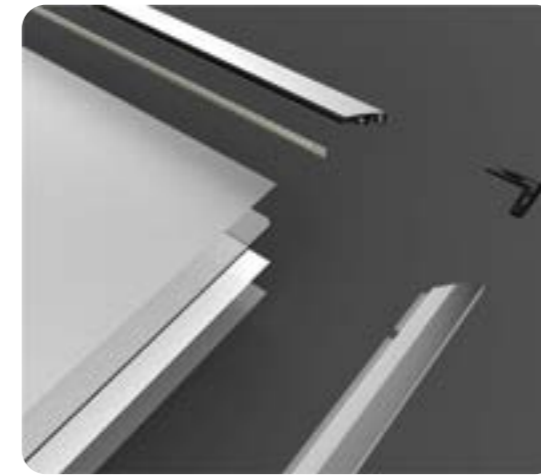

PAN300

AL

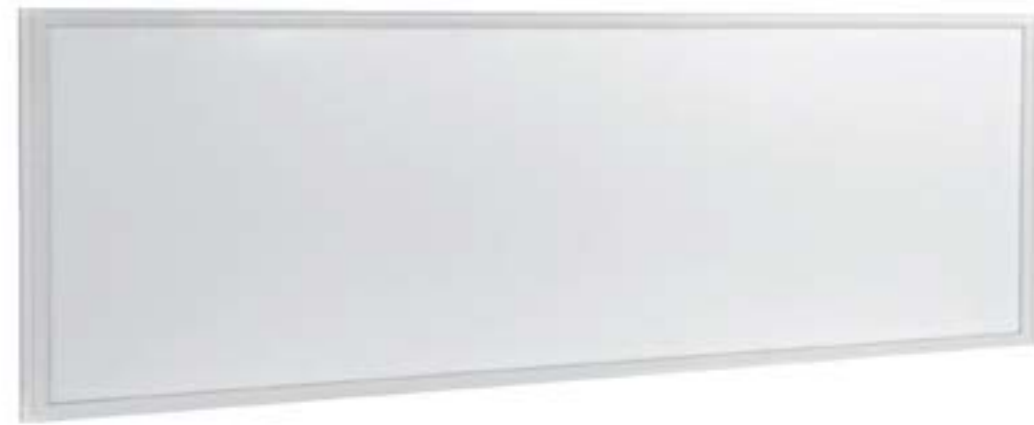

MOUNTING OPTIONS AVAILABLE - SURFACE/T BAR/ PLASTER/WIRE



36W or 40W 3400lm+ 295x1195mm 80-95+ Available 3 in 1

LED PANEL EXPLODED VIEW

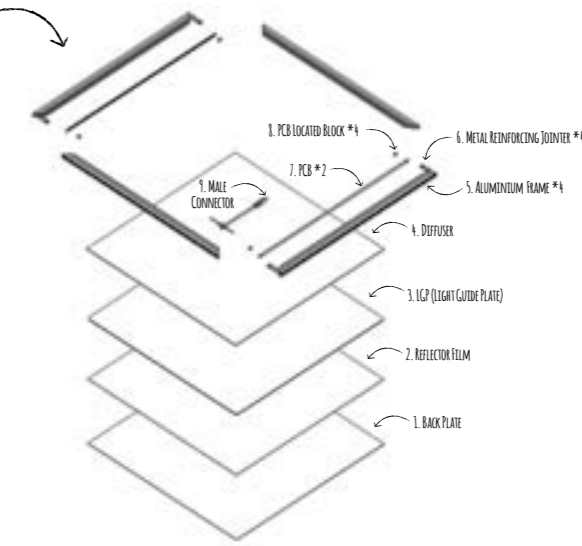

URG19 PANELS

| | PAN300-3 | PAN300-3-10V | PAN300-3-DA | PAN300-3-PH | PAN300-90 4K | PAN300-90 4K-10V | PAN300-90 4K-DA | PAN300-90 4K-PH | PAN300-95 4K | PAN300-95 4K-10V | PAN300-95 4K-DA | PAN300-95 4K-PH | PAN300-95 4K-SEN | PAN300-URG19 4K | PAN300-URG19 4K-10V | PAN300-URG19 4K-DA | PAN300-URG19 4K-PH | PAN300-URG19-90 4K | PAN300-URG19-90 4K-10V | PAN300-URG19-90 4K-DA | PAN300-URG19-90 4K-PH | PAN300-URG19-95 4K | PAN300-URG19-95 4K-10V | PAN300-URG19-95 4K-DA | PAN300-URG19-95 4K-PH | PAN300-URG19-95 4K-SEN | |
|-------------|--------------------------|-------------------|-------------------|-------------------|--------------|------------------|-----------------|-----------------|--------------|------------------|-----------------|-----------------|----------------------|-----------------|---------------------|--------------------|--------------------|--------------------|------------------------|-----------------------|-----------------------|--------------------|------------------------|-----------------------|-----------------------|------------------------|--------------|
| WATTS | 36W | 36W | 36W | 36W | 40W | 40W | 40W | 40W | 40W | 40W | 40W | 40W | 40W | 40W | 40W | 40W | 40W | 40W | 40W | 40W | 40W | 40W | 40W | 40W | 40W | 40W | 40W |
| LUMEN | 3500lm | 3500lm | 3500lm | 3500lm | 3600lm | 3600lm | 3600lm | 3600lm | 3400lm | 3400lm | 3400lm | 3400lm | 3400lm | 4000lm | 4000lm | 4000lm | 4000lm | 3600lm | 3600lm | 3600lm | 3600lm | 3400lm | 3400lm | 3400lm | 3400lm | 3400lm | 3400lm |
| DIMENSIONS | 295 x 1195mm | 295 x 1195mm | 295 x 1195mm | 295 x 1195mm | 295 x 1195mm | 295 x 1195mm | 295 x 1195mm | 295 x 1195mm | 295 x 1195mm | 295 x 1195mm | 295 x 1195mm | 295 x 1195mm | 295 x 1195mm | 295 x 1195mm | 295 x 1195mm | 295 x 1195mm | 295 x 1195mm | 295 x 1195mm | 295 x 1195mm | 295 x 1195mm | 295 x 1195mm | 295 x 1195mm | 295 x 1195mm | 295 x 1195mm | 295 x 1195mm | 295 x 1195mm | 295 x 1195mm |
| LED QTY | 240 | 240 | 240 | 240 | 224 | 224 | 224 | 224 | 224 | 224 | 224 | 224 | 224 | 224 | 224 | 224 | 224 | 224 | 224 | 224 | 224 | 224 | 224 | 224 | 224 | 224 | 224 |
| WEIGHT | 2.4kg | 2.4kg | 2.4kg | 2.4kg | 2.35kg | 2.35kg | 2.35kg | 2.35kg | 2.35kg | 2.35kg | 2.35kg | 2.35kg | 2.35kg | 2.45kg | 2.45kg | 2.45kg | 2.45kg | 2.45kg | 2.45kg | 2.45kg | 2.45kg | 2.45kg | 2.45kg | 2.45kg | 2.45kg | 2.45kg | 2.45kg |
| DIMMABLE | No | 1-10V | DALI | PHASE | No | 1-10V | DALI | PHASE | No | 1-10V | DALI | PHASE | SENOR DIM (merrytek) | No | 1-10V | DALI | PHASE | No | 1-10V | DALI | PHASE | No | 1-10V | DALI | PHASE | SENOR DIM (merrytek) | |
| RATING | IP40 | IP40 | IP40 | IP40 | IP40 | IP40 | IP40 | IP40 | IP40 | IP40 | IP40 | IP40 | IP40 | IP40 | IP40 | IP40 | IP40 | IP40 | IP40 | IP40 | IP40 | IP40 | IP40 | IP40 | IP40 | IP40 | IP40 |
| BEAM | 112° | 112° | 112° | 112° | 112° | 112° | 112° | 112° | 112° | 112° | 112° | 112° | 112° | 90° | 90° | 90° | 90° | 90° | 90° | 90° | 90° | 90° | 90° | 90° | 90° | 90° | 90° |
| COLOUR TEMP | 3000K 4000K 6000K | 3000K 4000K 6000K | 3000K 4000K 6000K | 3000K 4000K 6000K | 4000K | 4000K | 4000K | 4000K | 4000K | 4000K | 4000K | 4000K | 4000K | 4000K | 4000K | 4000K | 4000K | 4000K | 4000K | 4000K | 4000K | 4000K | 4000K | 4000K | 4000K | 4000K | 4000K |
| CRI | 80+ R9>0 | 80+ R9>0 | 80+ R9>0 | 80+ R9>0 | 90+ | 90+ | 90+ | 90+ | 95+ | 95+ | 95+ | 95+ | 95+ | 80+ R9>0 | 80+ R9>0 | 80+ R9>0 | 80+ R9>0 | 90+ | 90+ | 90+ | 90+ | 95+ | 95+ | 95+ | 95+ | 95+ | |
| UGR | 22 | 22 | 22 | 22 | 22 | 22 | 22 | 22 | 22 | 22 | 22 | 22 | 22 | 19 | 19 | 19 | 19 | 19 | 19 | 19 | 19 | 19 | 19 | 19 | 19 | 19 | 19 |
| STOCK | INSTOCK | INDENT | INDENT | INDENT | INDENT | INDENT | INDENT | INDENT | INDENT | INDENT | INDENT | INDENT | INDENT | INDENT | INDENT | INDENT | INDENT | INDENT | INDENT | INDENT | INDENT | INDENT | INDENT | INDENT | INDENT | INDENT | INDENT |

PAN600

AL



MOUNTING OPTIONS AVAILABLE - SURFACE/T BAR/PLASTER/WIRE



WATTAGE



LUMEN



OVERALL



CRI



DIMMABLE



3 CCT

36W or 40W 3400lm+ 595x595mm 80-95+ Available 3 in 1

LED PANEL EXPLODED VIEW

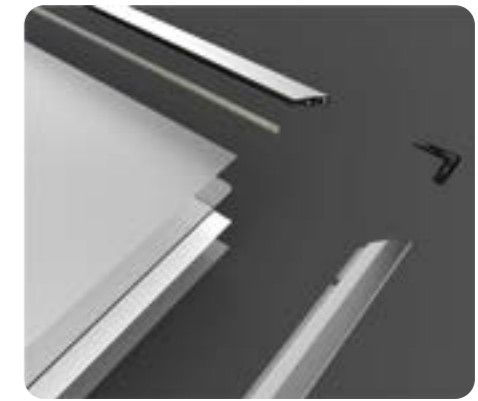
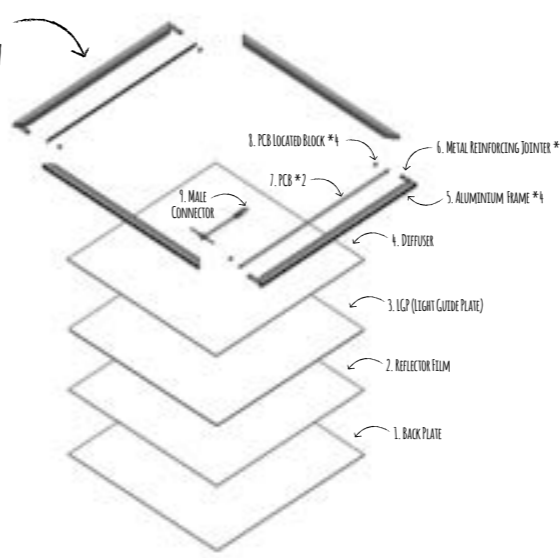

URG19 PANELS

| | PAN600-3-10V | PAN600-3-DA | PAN600-3-PH | PAN600-90 4K | PAN600-90 4K-10V | PAN600-90 4K-DA | PAN600-90 4K-PH | PAN600-95 4K | PAN600-95 4K-10V | PAN600-95 4K-DA | PAN600-95 4K-PH | PAN600-95 4K-SEN | | | | | | | | | | | | PAN600-URG19 4K | PAN600-URG19 4K-10V | PAN600-URG19 4K-DA | PAN600-URG19 4K-PH | PAN600-URG19-90 4K | PAN600-URG19-90 4K-10V | PAN600-URG19-90 4K-DA | PAN600-URG19-90 4K-PH | PAN600-URG19-95 4K | PAN600-URG19-95 4K-10V | PAN600-URG19-95 4K-DA | PAN600-URG19-95 4K-PH | PAN600-URG19-95 4K-SEN | | | |
|-------------|-------------------------|-------------------------|-------------------------|-------------------------|------------------|-----------------|-----------------|--------------|------------------|-----------------|-----------------|------------------|----------------------|--|--|--|--|--|--|--|--|--|--|-----------------|---------------------|--------------------|--------------------|--------------------|------------------------|-----------------------|-----------------------|--------------------|------------------------|-----------------------|-----------------------|------------------------|----------------------|--------|-------|
| WATTS | 36W | 36W | 36W | 40W | 40W | 40W | 40W | 40W | 40W | 40W | 40W | 40W | 40W | | | | | | | | | | | | 40W | 40W | 40W | 40W | 40W | 40W | 40W | 40W | 40W | 40W | 40W | 40W | 40W | 40W | |
| LUMEN | 3700lm | 3700lm | 3700lm | 3600lm | 3600lm | 3600lm | 3600lm | 3400lm | 3400lm | 3400lm | 3400lm | 3400lm | 3400lm | | | | | | | | | | | | 4000lm | 4000lm | 4000lm | 4000lm | 3600lm | 3600lm | 3600lm | 3600lm | 3400lm | 3400lm | 3400lm | 3400lm | 3400lm | | |
| DIMENSIONS | 595 x 595mm | 595 x 595mm | 595 x 595mm | 595 x 595mm | 595 x 595mm | 595 x 595mm | 595 x 595mm | 595 x 595mm | 595 x 595mm | 595 x 595mm | 595 x 595mm | 595 x 595mm | 595 x 595mm | | | | | | | | | | | | 595 x 595mm | 595 x 595mm | 595 x 595mm | 595 x 595mm | 595 x 595mm | 595 x 595mm | 595 x 595mm | 595 x 595mm | 595 x 595mm | 595 x 595mm | 595 x 595mm | 595 x 595mm | 595 x 595mm | | |
| LED QTY | 240 | 240 | 240 | 224 | 224 | 224 | 224 | 224 | 224 | 224 | 224 | 224 | 224 | | | | | | | | | | | | 224 | 224 | 224 | 224 | 224 | 224 | 224 | 224 | 224 | 224 | 224 | 224 | 224 | 224 | |
| WEIGHT | 2.3kg | 2.3kg | 2.3kg | 2.2kg | 2.2kg | 2.2kg | 2.2kg | 2.2kg | 2.2kg | 2.2kg | 2.2kg | 2.2kg | 2.2kg | | | | | | | | | | | | 2.45kg | 2.45kg | 2.45kg | 2.45kg | 2.45kg | 2.45kg | 2.45kg | 2.45kg | 2.45kg | 2.45kg | 2.45kg | 2.45kg | 2.45kg | 2.45kg | |
| DIMMABLE | No | 1-10V | DALI | PHASE | No | 1-10V | DALI | PHASE | No | 1-10V | DALI | PHASE | SENOR DIM (merrytek) | | | | | | | | | | | | No | 1-10V | DALI | PHASE | No | 1-10V | DALI | PHASE | No | 1-10V | DALI | PHASE | SENOR DIM (merrytek) | | |
| RATING | IP40 | IP40 | IP40 | IP40 | IP40 | IP40 | IP40 | IP40 | IP40 | IP40 | IP40 | IP40 | IP40 | | | | | | | | | | | | IP40 | IP40 | IP40 | IP40 | IP40 | IP40 | IP40 | IP40 | IP40 | IP40 | IP40 | IP40 | IP40 | IP40 | |
| BEAM | 112° | 112° | 112° | 112° | 112° | 112° | 112° | 112° | 112° | 112° | 112° | 112° | 112° | | | | | | | | | | | | 90° | 90° | 90° | 90° | 90° | 90° | 90° | 90° | 90° | 90° | 90° | 90° | 90° | 90° | |
| COLOUR TEMP | 3000K 4000K 6000K | 3000K 4000K 6000K | 3000K 4000K 6000K | 3000K 4000K 6000K | 4000K | 4000K | 4000K | 4000K | 4000K | 4000K | 4000K | 4000K | 4000K | | | | | | | | | | | | 4000K | 4000K | 4000K | 4000K | 4000K | 4000K | 4000K | 4000K | 4000K | 4000K | 4000K | 4000K | 4000K | 4000K | 4000K |
| CRI | 80+ R9>0 | 80+ R9>0 | 80+ R9>0 | 90+ | 90+ | 90+ | 90+ | 95+ | 95+ | 95+ | 95+ | 95+ | 95+ | | | | | | | | | | | | 80+ R9>0 | 80+ R9>0 | 80+ R9>0 | 80+ R9>0 | 90+ | 90+ | 90+ | 90+ | 95+ | 95+ | 95+ | 95+ | 95+ | 95+ | |
| UGR | 22 | 22 | 22 | 22 | 22 | 22 | 22 | 22 | 22 | 22 | 22 | 22 | 22 | | | | | | | | | | | | 19 | 19 | 19 | 19 | 19 | 19 | 19 | 19 | 19 | 19 | 19 | 19 | 19 | 19 | 19 |
| STOCK | INSTOCK | INDENT | INDENT | INDENT | INDENT | INDENT | INDENT | INDENT | INDENT | INDENT | INDENT | INDENT | INDENT | | | | | | | | | | | | INDENT | INDENT | INDENT | INDENT | INDENT | INDENT | INDENT | INDENT | INDENT | INDENT | INDENT | INDENT | INDENT | INDENT | |



MOUNTING OPTIONS AVAILABLE
- SURFACE/T BAR/ PLASTER/WIRE

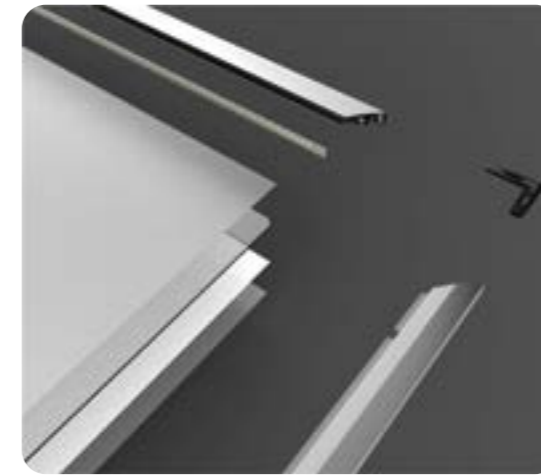

LED PANEL EXPLODED VIEW

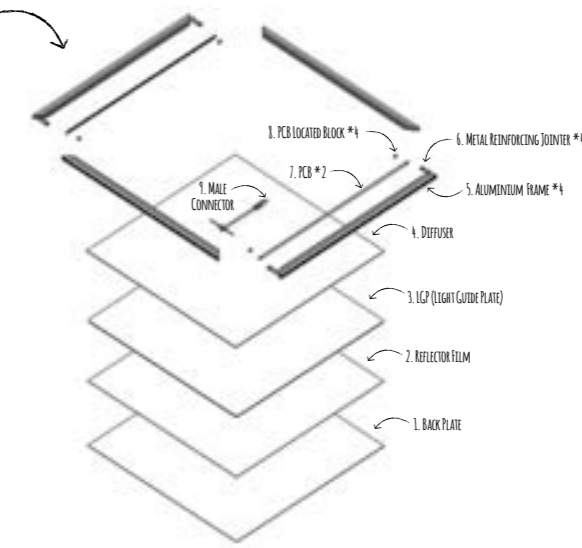

WATTAGE



LUMEN



OVERALL



CRI



DIMMABLE



3CCT

50W, 52W or 60W 4750lm+ 595x1195mm 80-95+ Available 3 in 1

URG19 PANELS

| | PAN1200-3 | PAN1200-3-10V | PAN1200-3-DA | PAN1200-3-PH | PAN1200-90 4K | PAN1200-90 4K-10V | PAN1200-90 4K-DA | PAN1200-90 4K-PH | PAN1200-95 4K | PAN1200-95 4K-10V | PAN1200-95 4K-DA | PAN1200-95 4K-PH | PAN1200-95 4K-SEN | PAN1200-URG19 4K | PAN1200-URG19 4K-10V | PAN1200-URG19 4K-DA | PAN1200-URG19 4K-PH | PAN1200-URG19-90 4K | PAN1200-URG19-90 4K-10V | PAN1200-URG19-90 4K-DA | PAN1200-URG19-90 4K-PH | PAN1200-URG19-95 4K | PAN1200-URG19-95 4K-10V | PAN1200-URG19-95 4K-DA | PAN1200-URG19-95 4K-PH | PAN1200-URG19-95 4K-SEN |
|-------------|----------------------------------|-------------------------|-------------------------|-------------------------|---------------|-------------------|------------------|------------------|---------------|-------------------|------------------|------------------|----------------------|------------------|----------------------|---------------------|---------------------|---------------------|-------------------------|------------------------|------------------------|---------------------|-------------------------|------------------------|------------------------|-------------------------|
| WATTS | 52W | 52W | 52W | 52W | 60W | 60W | 60W | 50W | 60W | 60W | 60W | 50W | 50W | 60W | 60W | 60W | 50W | 60W | 60W | 60W | 50W | 60W | 60W | 60W | 50W | 50W |
| LUMEN | 5850lm | 5850lm | 5850lm | 5850lm | 6000lm | 6000lm | 6000lm | 5000lm | 5700lm | 5700lm | 5700lm | 4750lm | 4750lm | 6500lm | 6500lm | 6500lm | 5500lm | 6000lm | 6000lm | 6000lm | 5000lm | 5700lm | 5700lm | 5700lm | 4750lm | 4750lm |
| DIMENSIONS | 595 x 1195mm | 595 x 1195mm | 595 x 1195mm | 595 x 1195mm | 595 x 1195mm | 595 x 1195mm | 595 x 1195mm | 595 x 1195mm | 595 x 1195mm | 595 x 1195mm | 595 x 1195mm | 595 x 1195mm | 595 x 1195mm | 595 x 1195mm | 595 x 1195mm | 595 x 1195mm | 595 x 1195mm | 595 x 1195mm | 595 x 1195mm | 595 x 1195mm | 595 x 1195mm | 595 x 1195mm | 595 x 1195mm | 595 x 1195mm | 595 x 1195mm | 595 x 1195mm |
| LED QTY | 476 | 476 | 476 | 476 | 476 | 476 | 476 | 476 | 476 | 476 | 476 | 476 | 476 | 476 | 476 | 476 | 476 | 476 | 476 | 476 | 476 | 476 | 476 | 476 | 476 | 476 |
| WEIGHT | 4.2kg | 4.2kg | 4.2kg | 4.2kg | 4.15kg | 4.15kg | 4.15kg | 4.15kg | 4.15kg | 4.15kg | 4.15kg | 4.15kg | 4.15kg | 4.45kg | 4.45kg | 4.45kg | 4.45kg | 4.45kg | 4.45kg | 4.45kg | 4.45kg | 4.45kg | 4.45kg | 4.45kg | 4.45kg | 4.45kg |
| DIMMABLE | No | 1-10V | DALI | PHASE | No | 1-10V | DALI | PHASE | No | 1-10V | DALI | PHASE | SENOR DIM (merrytek) | No | 1-10V | DALI | PHASE | No | 1-10V | DALI | PHASE | No | 1-10V | DALI | PHASE | SENOR DIM (merrytek) |
| RATING | IP40 | IP40 | IP40 | IP40 | IP40 | IP40 | IP40 | IP40 | IP40 | IP40 | IP40 | IP40 | IP40 | IP40 | IP40 | IP40 | IP40 | IP40 | IP40 | IP40 | IP40 | IP40 | IP40 | IP40 | IP40 | IP40 |
| BEAM | 112° | 112° | 112° | 112° | 112° | 112° | 112° | 112° | 112° | 112° | 112° | 112° | 112° | 90° | 90° | 90° | 90° | 90° | 90° | 90° | 90° | 90° | 90° | 90° | 90° | 90° |
| COLOUR TEMP | 3000K 4000K 6000K | 3000K 4000K 6000K | 3000K 4000K 6000K | 3000K 4000K 6000K | 4000K | 4000K | 4000K | 4000K | 4000K | 4000K | 4000K | 4000K | 4000K | 4000K | 4000K | 4000K | 4000K | 4000K | 4000K | 4000K | 4000K | 4000K | 4000K | 4000K | 4000K | 4000K |
| CRI | 80+ R9>0 | 80+ R9>0 | 80+ R9>0 | 80+ R9>0 | 90+ | 90+ | 90+ | 90+ | 95+ | 95+ | 95+ | 95+ | 95+ | 80+ R9>0 | 80+ R9>0 | 80+ R9>0 | 80+ R9>0 | 90+ | 90+ | 90+ | 90+ | 95+ | 95+ | 95+ | 95+ | 95+ |
| UGR | 22 | 22 | 22 | 22 | 22 | 22 | 22 | 22 | 22 | 22 | 22 | 22 | 22 | 19 | 19 | 19 | 19 | 19 | 19 | 19 | 19 | 19 | 19 | 19 | 19 | 19 |
| STOCK | INSTOCK | INDENT | INDENT | INDENT | INDENT | INDENT | INDENT | INDENT | INDENT | INDENT | INDENT | INDENT | INDENT | INDENT | INDENT | INDENT | INDENT | INDENT | INDENT | INDENT | INDENT | INDENT | INDENT | INDENT | INDENT | INDENT |

EMERGENCY

Hugo's surface mounted LED emergency luminaires offer an exceptional D32-D100 classification and are made from fire retardant acrylic.

Hugo's recessed single point LED emergency luminaires have D32, D63 or D100 classifications. The unique fittings come as complete units, including built in inverter, batteries and head making installation simple and effective.

EXIT

Hugo exit and emergency luminaires utilise state of the art electronic inverters to provide superior reliability and a cost effective lighting solution. The range features a variety of classifications in recessed and surface mounted variations with integral battery. All comply with AS/NZ2293.







Pictograms should be used in new buildings or refurbishments where an entire building or floors exits signs are being replaced. This is to avoid confusion where existing exit wording and pictograms may be installed in the same floor areas.

Exit decals available on request.

EMGSM64/100

MW









| | | |
|--|--|---|
|  WATTAGE 9/10W |  OVERALL 100x125mm |  DURATION 2hr |
|  RECHARGE 16HR |  WEIGHT 0.7KG |  INPUT 220-240V |

| | EMGSM64 | EMGSM100 |
|----------------|----------------|----------|
| WATTS | 9W | 10W |
| INPUT | 220 - 240V | |
| MODEL | Non-maintained | |
| DURATION | 2hr | |
| WEIGHT | 0.7KG | |
| RECHARGE | 16hr | |
| OVERALL | 100 x 125mm | |
| CLASSIFICATION | D63 | D100 |
| BASE | - | |

EMGRC32/64

MW









| | | |
|--|---|---|
|  WATTAGE 3W |  CUTOUT 95x145mm |  DURATION 2hr |
|  RECHARGE 16HR |  WEIGHT 0.3-0.4KG |  INPUT 220-240V |

| | EMGRC32 | EMGRC64 |
|----------------|----------------|---------|
| WATTS | 3W | |
| INPUT | 220 - 240V | |
| MODEL | Non-maintained | |
| DURATION | 2hr | |
| WEIGHT | 0.3KG | 0.4KG |
| RECHARGE | 16hr | |
| OVERALL | H: 90mm | |
| CLASSIFICATION | D32 | D63 |
| BASE | - | |

EMEXLEDMR

MW



| | | |
|--|---|---|
|  WATTAGE 1.2W |  OVERALL 158x316x90mm |  DURATION 2hr |
|  RECHARGE 24HR |  WEIGHT 1.2KG |  INPUT 220-240V |

| | EMEXLEDMR |
|----------------|------------------|
| WATTS | 1.2W |
| INPUT | 220 - 240V |
| MODEL | Maintained |
| DURATION | 2hr |
| WEIGHT | 1.2KG |
| RECHARGE | 24hr |
| OVERALL | 158 x 316 x 90mm |
| CLASSIFICATION | - |
| BASE | 85 x 320 x 45mm |

WATTS
INPUT
MODEL
DURATION
WEIGHT
RECHARGE
OVERALL
CLASSIFICATION
BASE

WATTS
INPUT
MODEL
DURATION
WEIGHT
RECHARGE
OVERALL
CLASSIFICATION
BASE



LED EXTR

SURFACE MOUNTED



WATTAGE
1.2W

OVERALL
243x316x45mm

DURATION
2hr

RECHARGE
24HR

WEIGHT
1.2KG

INPUT
220-240V

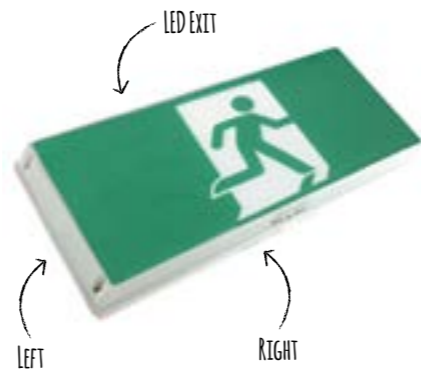

LED EXTR

LEFT

RIGHT



WATTAGE
1.2W

OVERALL
183x420x68mm

DURATION
3hr

RECHARGE
24HR

WEIGHT
1.2KG

INPUT
220-240V

| | | |
|----------|------------------|------------------|
| WATTS | 1.2W | 1.2W |
| INPUT | 220 - 240V | 220 - 240V |
| MODEL | Maintained | Maintained |
| DURATION | 2hr | 2hr |
| WEIGHT | 1.2KG | 1.2KG |
| RECHARGE | 24hr | 24hr |
| OVERALL | 243 x 316 x 45mm | 183 x 420 x 68mm |
| BASE | 45 x 85mm | - |

LED STRIP

LED strip is a fantastic way to brighten up any space and is perfectly matched with our recessed or surface mounted extrusion.

With a range of colours and low running cost is a perfect way to highlight your next project.



For colour consistency we only recommend a max run of 100W per Amplifier.

The length of RGB strip will be dependent on the LED Driver and watts per metre of the strip.

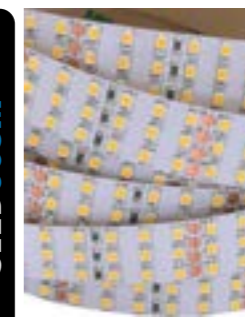

3000K



WATTAGE
30W/m

LUMEN
1750lm/m

CURRENT
24V DC

WIDTH
20mm

PROJECTION
2.2mm

LED COLOUR
3000K



3000 & 4000K



WATTAGE
20W/m

LUMEN
1160lm/m

CURRENT
24V DC

WIDTH
15mm

PROJECTION
2.5mm

LED COLOUR
2 Colours

| | | |
|-------------|--------|--------------|
| WATTS/M | 30W | 20W |
| LUMEN/M | 1750lm | 1160lm |
| INPUT | 24V DC | 24V DC |
| LED/M | 360 | 240 |
| WIDTH | 20mm | 15mm |
| PROJECTION | 2.2mm | 2.5mm |
| COLOUR TEMP | 3000K | 3000K, 4000K |
| CUT-POINT | 50mm | 25mm |

SLED502M



3000K & 4000K



WATTAGE
30W/m



LUMEN
1700lm/m



CURRENT
24V DC



WIDTH
20mm



PROJECTION
2.2mm



LED COLOUR
2 Colours

SLED500M



3000K & 4000K



WATTAGE
14W/m



LUMEN
850lm/m



CURRENT
24V DC



WIDTH
12mm



PROJECTION
2.2mm



LED COLOUR
2 Colours

SLED300M



Blue, Red, 3000K & 4000K



WATTAGE
9W/m



LUMEN
580lm/m



CURRENT
12V DC



WIDTH
8mm



PROJECTION
2.2mm



LED COLOUR
4 Colours

SLED200M



Red, 3000K & 4000K



WATTAGE
4.5W/m



LUMEN
300lm/m



CURRENT
12V DC



WIDTH
8mm



PROJECTION
2.2mm



LED COLOUR
3 Colours

SLED511M



4000K



WATTAGE
14W/m



LUMEN
850lm/m



CURRENT
24V DC



WIDTH
15mm



PROJECTION
5mm



IP
IP65

SLED311M



3000K & 4000K



WATTAGE
9W/m



LUMEN
580lm/m



CURRENT
12V DC



WIDTH
12mm



PROJECTION
5mm



IP
IP65

SLED211M



3000K & 4000K



WATTAGE
4.5W/m



LUMEN
300lm/m



CURRENT
12V DC



WIDTH
12mm



PROJECTION
6mm



IP
IP65

SLED300MRGB



RGB



WATTAGE
14W/m



CUT-POINT
50mm



CURRENT
12V DC



WIDTH
12mm



PROJECTION
2.2mm



LED COLOUR
RGB

| WATTS/M | 30W | 14W | 9W | 4.5W |
|-------------|--------------|--------------|-------------------------|-------------------|
| LUMEN/M | 1700lm | 850lm | 580lm | 300lm |
| INPUT | 24V DC | 24V DC | 12V DC | 12V DC |
| LED/M | 120 | 60 | 120 | 60 |
| WIDTH | 20mm | 12mm | 8mm | 8mm |
| PROJECTION | 2.2mm | 2.2mm | 2.2mm | 2.2mm |
| COLOUR TEMP | 3000K, 4000K | 3000K, 4000K | Blue, Red, 3000K, 4000K | Red, 3000K, 4000K |
| CUT-POINT | 50mm | 100mm | 25mm | 50mm |

| WATTS/M | 14W | 9W | 4.5W | 14W |
|-------------|--------------|--------------|--------------|--------|
| LUMEN/M | 850lm | 580lm | 300lm | 14W |
| INPUT | 24V DC | 12V DC | 12V DC | 12V DC |
| LED/M | 60 | 120 | 60 | 60 |
| WIDTH | 15mm | 12mm | 12mm | 12mm |
| PROJECTION | 5mm | 5mm | 6mm | 2.2mm |
| COLOUR TEMP | 3000K, 4000K | 3000K, 4000K | 3000K, 4000K | RGB |
| CUT-POINT | 100mm | 25mm | 50mm | 50mm |

SLED200MRGB

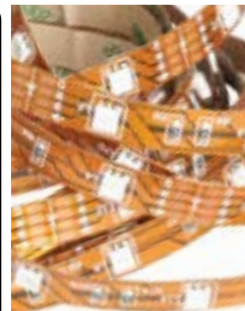

RGB



WATTAGE
7W/m



CURRENT
12V DC



WIDTH
10mm



PROJECTION
2.2mm



LED COLOUR
RGB

SLED211MRGB



RGB



WATTAGE
7W/m



CURRENT
12V DC



WIDTH
12mm



PROJECTION
5mm



LED COLOUR
RGB



IP
IP65

SLED311MRGB



RGB



WATTAGE
14W/m



CURRENT
12V DC



WIDTH
12mm



PROJECTION
5mm



LED COLOUR
RGB



IP
IP65

SLEDAMP



COLOUR CHANGING
AMPLIFIER

SLEDRGB3



RECEIVER
COLOUR CHANGING
CONTROLLER

| WATTS/M | 7W | 7W | 14W |
|-------------|--------|--------|--------|
| LUMEN/M | - | - | - |
| INPUT | 12V DC | 12V DC | 12V DC |
| LED/M | 30 | 30 | 60 |
| WIDTH | 10mm | 12mm | 12mm |
| PROJECTION | 2.2mm | 5mm | 5mm |
| COLOUR TEMP | RGB | RGB | RGB |
| CUT-POINT | 100mm | 100mm | 50mm |

ALS900



END CAPS AVAILABLE & SUPPLIED
FOR ALUMINIUM EXTRUSION



LENGTH
2m



WIDTH
16mm



HEIGHT
16mm



LED STRIP WIDTH
9.5mm

ALS90RO



END CAPS AVAILABLE & SUPPLIED
FOR ALUMINIUM EXTRUSION



LENGTH
2m



WIDTH
16mm



HEIGHT
16mm



LED STRIP WIDTH
9.5mm

ALR680



RECESSED
END CAPS AVAILABLE & SUPPLIED
FOR ALUMINIUM EXTRUSION



LENGTH
2.5m



WIDTH
58mm



RECESS
67mm



CUTOUT
46mm

ALS90LO



END CAPS AVAILABLE & SUPPLIED
FOR ALUMINIUM EXTRUSION



LENGTH
2.5m



WIDTH
56mm

| LENGTH | 2m | 2m | 2.5m sold per 1m | 2.5m sold per 1m | LENGTH |
|------------------------|-------|-------|------------------|------------------|-----------------|
| WIDTH | 16mm | 16mm | 58mm | 56mm | WIDTH |
| HEIGHT | 16mm | 16mm | 68mm | 56mm | HEIGHT |
| RECESS | - | - | 67mm | - | RECESS |
| CUTOUT | - | - | 46mm | - | CUTOUT |
| LED STRIP WIDTH | 9.5mm | 9.5mm | 16mm x3 | 57mm | LED STRIP WIDTH |
| Recommended Strip SLED | | | | | |
| 300M | Yes | Yes | - | - | 300M |
| 500M | Yes | Yes | Yes | Yes | 500M |
| 600M | - | - | Yes | Yes | 600M |
| 502M | - | - | Yes | Yes | 502M |
| 603M | - | - | Yes | Yes | 603M |

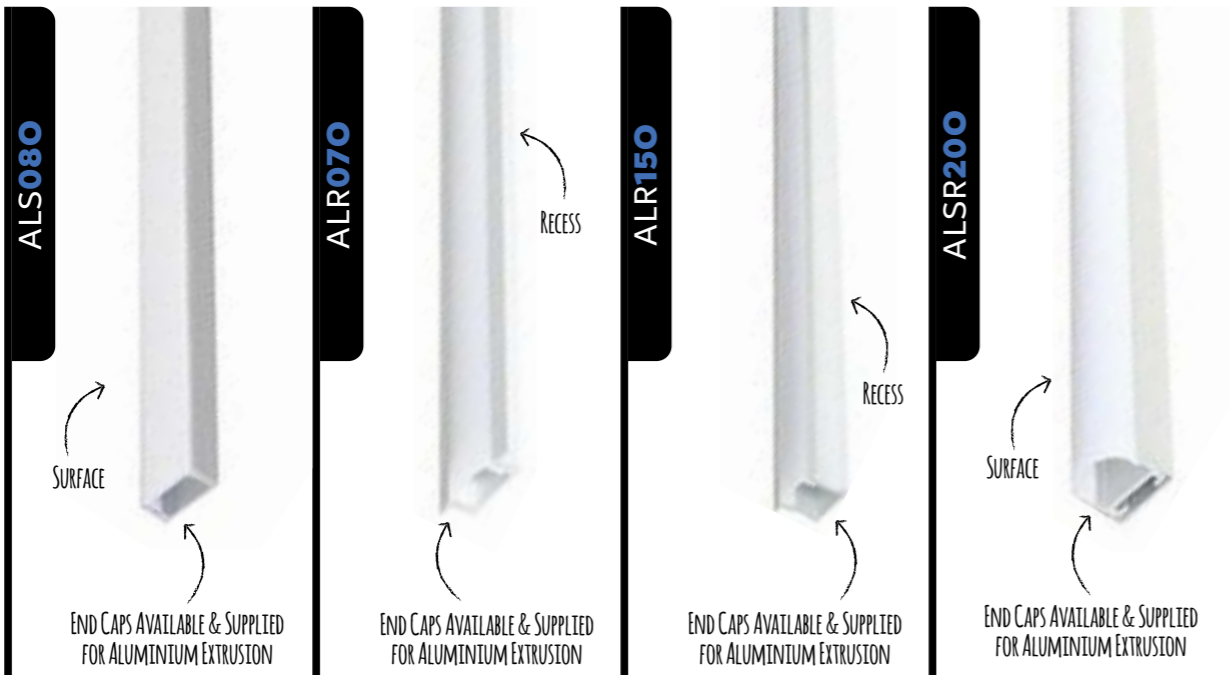

END CAPS AVAILABLE & SUPPLIED FOR ALUMINIUM EXTRUSION

END CAPS AVAILABLE & SUPPLIED FOR ALUMINIUM EXTRUSION

END CAPS AVAILABLE & SUPPLIED FOR ALUMINIUM EXTRUSION

END CAPS AVAILABLE & SUPPLIED FOR ALUMINIUM EXTRUSION

LENGTH **2m**
 WIDTH **17mm**
 HEIGHT **8mm**
 LED STRIP WIDTH **12mm**

LENGTH **2m**
 WIDTH **24mm**
 HEIGHT **8mm**
 RECESS **5.6mm**
 CUTOUT **17.3mm**

LENGTH **2m**
 WIDTH **23mm**
 HEIGHT **15.4mm**
 RECESS **12.8mm**
 CUTOUT **17.3mm**

LENGTH **2m**
 WIDTH **20mm**
 HEIGHT **20mm**
 LED STRIP WIDTH **12mm**

| | | | | |
|-----------------|------------------------|--------|--------|------|
| LENGTH | 2m | 2m | 2m | 2m |
| WIDTH | 17mm | 24mm | 23mm | 20mm |
| HEIGHT | 8mm | 8mm | 15.4mm | 20mm |
| RECESS | - | 5.6mm | 12.8mm | - |
| CUTOUT | - | 17.3mm | 17.3mm | - |
| LED STRIP WIDTH | 12mm | 12mm | 12mm | 16mm |
| | Recommended Strip SLED | | | |
| 300M | Yes | Yes | Yes | Yes |
| 500M | Yes | - | - | - |
| 600M | - | - | Yes | Yes |
| 502M | - | - | - | - |
| 603M | - | - | - | - |

CONSTANT VOLTAGE DRIVERS

Constant voltage generally requires 12V or 24V DC input and must be wired in parallel. It is traditionally used for decorative lighting such as 'low level' wall or 'strip lighting'. Please ensure power is turned off when connecting products to driver. Products connected to a live circuit will cause damage to the LED's.

LED7512CV/7524CV



CURRENT **12/24V DC**
 INPUT **230V**
 IP **IP20**

LEDCVCC



CURRENT **12/24V DC**
 INPUT **350/700mA**
 IP **IP20**

LED2512CVD



CURRENT **12V DC**
 INPUT **230V**
 IP **IP20**
 DIMMABLE **Yes**

| LED7512CV | LED7524CV | LEDCVCC | | LED2512CVD | WATTS |
|-----------------|-----------|-----------------|--------|-----------------|------------|
| 75W | 24V DC | 1 - 3W | 1 - 6W | 25W | |
| 12V DC | 24V DC | 350mA | 700mA | 12V DC | CURRENT |
| 230V | | 12V DC | 24V DC | 230V | INPUT |
| 61 x 33 x 185mm | | 30 x 14 x 7.5mm | | 52 x 30 x 123mm | DIMENSIONS |
| IP20 | | IP20 | | IP20 | IP |
| No | | No | | Yes | DIMMABLE |

CONSTANT CURRENT DRIVERS

Constant current generally requires 350mA, 500mA or 700mA input and must be wired in series. It is traditionally used for task lighting as the lumens are a lot higher. These are often found within fittings such as downlights. Please ensure power is turned off when connecting products to driver. Products connected to a live circuit will cause damage to the LED's.



CURRENT
350/700V DC

INPUT
230V

IP
IP65



CURRENT
350V DC

INPUT
230V

IP
IP20

| | LED043CC | LED047CC | LED043DCC | LED123CC1 | LED203CC | LED133DCC1 |
|------------|------------|------------|------------|------------|-------------|-------------|
| WATTS | 1-4W | 1-4W | 2-4W | 1-12W | 1-20W | 9-15W |
| CURRENT | 350mA | 700mA | 350mA | 350mA | 350mA | 350mA |
| INPUT | 230V | 230V | 230V | 230V | 230V | 230V |
| DIMENSIONS | 38x27x22mm | 38x27x22mm | 40x22x19mm | 98x39x22mm | 113x44x28mm | 123x45x29mm |
| IP | IP65 | IP65 | IP65 | IP20 | IP20 | IP20 |
| DIMMABLE | No | No | Yes | No | No | Yes |

CLASSIFICATION

Amendment A' includes classification in relation to insulation in the standard. There are 5 categories for recessed luminaires. All products must be tested and classified into each of these categories.

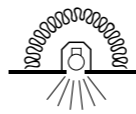

IC-F ABUTTED & COVERED

Building insulation can safely be continuously exposed to 90C allowed to ABUT and COVER luminaire. Residential or Commercial Installation. Within the testing standard there is a 1mm probe test that differentiates between IC-F and IC.

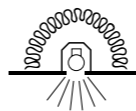

IC ABUTTED & COVERED

Building insulation that can safely be continuously exposed to 90C allowed to ABUT and COVER luminaire. Residential or Commercial Installation.

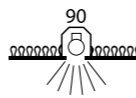

CA-90

Building insulation that can safely be continuously exposed to 90C allowed to ABUT the luminaire. Residential or Commercial Installation.

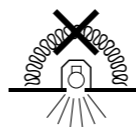

DO NOT COVER

Building insulation must not ABUT or COVER the luminaire. Residential or Commercial Installation.



NON-IC

Luminaires not suitable for covering or abutting with building insulation. Commercial Installation only.

BATHROOM ZONING

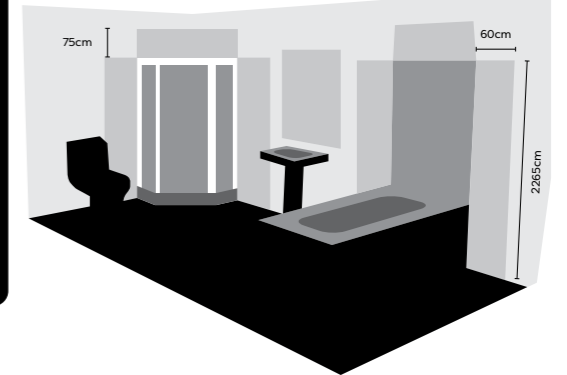

0

Area inside the bath or shower. A minimum of IP67 is required protected against immersion in water. Only SELV (max 12V) fittings can be used.

1

Area directly above the bath or shower tray and to a height of 2.25m. Minimum rating IP65.

2

Area above the bathtub or shower tray above the sides of Zone 1 up to a distance of 60cm. This is external to Zone 1 and extends vertically 0.6m to a height of 3m. IP64 is required.

T&C's

ELECTRICITY (SAFETY) REGULATIONS 2010

Hugo Lighting ensures all products sold are in conformity with the requirements of New Zealand legislation in line with NZS 60598 or the relevant standard.

RECEIPT OF GOODS

Goods must be inspected upon delivery from freight company. Any damages must be reported to the freight company and Hugo Lighting within 24 hours. Products must be left in original condition with original packaging. We are unable to claim for damages caused by freight after the 24 hour period.

RETURNS

Goods are only accepted as returns if faulty or incorrectly supplied. If other situations arise a re-stocking fee of 20% may apply. The invoice number must accompany the returned goods. Goods will not be accepted after 20 days of receipt of goods. All products have to be returned in original Hugo boxes unmarked and in first condition. Return expenses are to be paid by the customer.

CUT-OUTS

We do not recommend cutting holes for products before receiving the goods, as some information in the catalogue may have changed after printing.

DIMENSIONS

Measurements provided in the catalogue are accurate at time of publication but may vary during manufacturing. It is advised to confirm exact size specifications prior to installation. Hugo reserves the right to improve, modify or update the designs without prior notice.

WARRANTY INFORMATION

Hugo provides warranty between 1 and 5 years (dependent on the fitting), against defects in the material and/or workmanship. This period commences from the date of delivery and is only valid if the fitting is installed in accordance to the instructions provided and to local regulations.

If defective material or workmanship is found within the warranty period, it must be returned to the supplier with details and proof of the original delivery and purchase dates. Any additional costs including labour must be submitted in writing and approved by Hugo prior to remedial work being initiated.

Warranty becomes null and void if components have been tampered, altered or modified in any way. Damage to fittings by fire, water or similar will revoke the warranty.

INGRESS PROTECTION

**FIRST DIGIT
(PROTECTION
AGAINST SOLIDS)**

- 0** No Protection
- 1** Protection against solid objects greater than 50mm (e.g. accidental contact with hand)
- 2** Protection against solid objects greater than 12mm (e.g. accidental contact with finger)
- 3** Protection against solid objects greater than 2.5mm (e.g. tools and wires)
- 4** Protection against solid objects greater than 1mm (e.g. fine tools and wires)
- 5** Protected against dust
- 6** Total protection against dust

**SECOND DIGIT
(PROTECTION
AGAINST LIQUIDS)**

- 0** No Protection
- 1** Protection against vertical water drops (e.g. condensation)
- 2** Protection against direct sprays of water, up to 15° from vertical
- 3** Protection against direct sprays of water, up to 60° from vertical
- 4** Protection against water spray from all directions
- 5** Protection against low pressure jets of water
- 6** Protection against jets of water of similar force to heavy seas
- 7** Protection against immersion between 15-100cm

| | | | | | | | |
|--------------------------|-----|------------------------|-----|-------------------------|-----|------------------|-----|
| A Accent Light Rd | 17 | D DLEK222 | 37 | G GDL615 | 74 | S SCL118 | 22 |
| Accent Light Sq | 18 | DLEK223 | 41 | GDL616 | 74 | SCL218 | 20 |
| ALCGM1200 | 16 | DLEK224 | 35 | GDL633 | 72 | SCL3125 | 20 |
| ALCGM1800 | 16 | DLEK240 | 40 | GDL815 | 72 | SCL3218 | 21 |
| ALCGR1200 | 16 | DLEK261W4 | 40 | GDL816 | 71 | SCL3225 | 21 |
| ALCGR1800 | 16 | DLEK3110 | 41 | GDL817 | 71 | SCLG12W | 19 |
| ALCGS1200 | 17 | DLEK3125 | 42 | | | SCLG25W | 19 |
| ALCGS1800 | 17 | DLEK3220 | 35 | H HB100-5 | 86 | SEN701 | 95 |
| ALG1200 | 14 | DLEK3221 | 36 | HB125LG | 84 | SEN711 | 95 |
| ALG1800 | 14 | DLEK3222 | 37 | HB150-5 | 86 | SLED200M | 106 |
| ALM1200 | 15 | DLEK3223 | 38 | HB155LG | 85 | SLED200MRGB | 108 |
| ALM1800 | 15 | DLEK3231 | 34 | HB165LG | 85 | SLED211M | 107 |
| ALR070 | 110 | DLEK371 | 34 | HB200-5 | 87 | SLED211MRGB | 108 |
| ALR1200 | 14 | DLEK372 | 33 | HBREF | 87 | SLED300M | 106 |
| ALR150 | 110 | DLEK533 | 29 | | | SLED300MRGB | 107 |
| ALR1800 | 14 | DLEK534 | 29 | L LED043CC | 112 | SLED311M | 107 |
| ALR680 | 109 | DLEK536 | 30 | LED043DCC | 112 | SLED311MRGB | 108 |
| ALS080 | 110 | DLEK731 | 32 | LED047CC | 112 | SLED500M | 106 |
| ALS90LO | 109 | DLEK732 | 32 | LED123CC1 | 112 | SLED502M | 106 |
| ALS90O | 109 | DLEK741 | 31 | LED133DCC1 | 112 | SLED511M | 107 |
| ALS90RO | 109 | DLEK751 | 27 | LED203CC | 112 | SLED600M | 105 |
| ALSR200 | 110 | DLEK752 | 28 | LED2512CVD | 111 | SLED603M | 105 |
| ALW1200 | 15 | DLEK813 | 33 | LED7512CV | 111 | SLEDAMP | 108 |
| ALW1800 | 15 | DLEK924 | 31 | LED7524CV | 111 | SLEDRGB3 | 108 |
| | | DLEK926 | 30 | LEDCVCC | 111 | Spot Light | 18 |
| | | DLEK933 | 23 | | | SWL042 | 45 |
| B BAT025 | 88 | DLEK934 | 24 | M Microprismatic | 18 | SWL044 | 46 |
| BAT035 | 88 | DLEK935 | 24 | MKL364 | 50 | SWL046 | 46 |
| BAT048 | 88 | DLEK936 | 25 | MKL365 | 51 | SWL047 | 48 |
| BAT049 | 88 | DSK601 | 25 | MKL421 | 65 | SWL048 | 47 |
| BAT1200 | 89 | DSK602 | 26 | MKL422 | 66 | SWL101 | 61 |
| BAT1500 | 89 | DSK603 | 26 | MKL423 | 66 | SWL102 | 61 |
| BAT60 | 89 | | | MKL424 | 67 | SWL202 | 60 |
| BKH111 | 64 | E EMEXLDMQF | 104 | MKL425 | 51 | SWL242 | 55 |
| BKH1313 | 63 | EMEXLEDMR | 103 | MKL426 | 51 | SWL244 | 55 |
| BKH1314 | 63 | EMGRC32 | 103 | MKL435 | 67 | SWL245 | 54 |
| BKH631 | 62 | EMGSM64 | 102 | | | SWL336AC | 49 |
| BKH634 | 63 | EMGSM100 | 102 | P PAN1200 | 100 | SWL348AC | 48 |
| | | EMGRC64 | 103 | PAN300 | 96 | SWL349AC | 49 |
| C CB104 | 43 | | | PAN600 | 98 | SWL401 | 58 |
| CB303 | 43 | F FLO50 | 83 | PEN425 | 8 | SWL402 | 58 |
| CBLED04 | 94 | FL210 | 82 | PEN426 | 9 | SWL411 | 57 |
| CBLED09 | 94 | FL220 | 83 | PEN427 | 8 | SWL412 | 57 |
| CBLED10H | 92 | FLAC10 | 79 | PEN431 | 11 | SWL414 | 56 |
| CBLED13 | 94 | FLAC100 | 81 | PEN441 | 4 | SWL415 | 56 |
| CBLED15H | 93 | FLAC20 | 80 | PEN442 | 5 | SWL423 | 59 |
| CBLED18 | 94 | FLAC200 | 82 | PEN443 | 5 | SWL441 | 52 |
| CBLED20H | 93 | FLAC50 | 80 | PEN461 | 10 | SWL443 | 53 |
| CBLED22 | 94 | FLAC07RGB | 78 | PEN521 | 10 | SWL445 | 53 |
| CBT5300 | 94 | FLAC015RGB | 79 | PEN523 | 11 | SWL447 | 54 |
| CBT5500 | 94 | | | PEN532 | 6 | SWL522 | 59 |
| Corner Light | 18 | G General Light | 17 | PEN533 | 6 | SWL523 | 60 |
| | | GDL351 | 76 | PEN534 | 7 | SWL631 | 22 |
| D DLA220 | 34 | GDL352 | 77 | PEN542 | 7 | SWL632 | 23 |
| DLA372 | 33 | GDL353 | 77 | | | SWL803 | 62 |
| DLE3251 | 38 | GDL354 | 77 | R RWL321 | 65 | | |
| DLE3252 | 39 | GDL361 | 75 | RWL322 | 64 | W WP11200 | 90 |
| DLE3253 | 39 | GDL362 | 75 | RWL401 | 68 | WP11500 | 91 |
| DLED611WW | 44 | GDL364 | 76 | RWL602 | 68 | WP21500 | 91 |
| DLED613WW | 44 | GDL435 | 70 | | | WPEXITML | 104 |
| DLED812 | 42 | GDL436 | 69 | | | WPEXITMR | 104 |
| DLEK220 | 34 | GDL437 | 70 | | | WPEXITR | 104 |
| DLEK221 | 36 | GDL613 | 73 | | | | |
| | | GDL614 | 73 | | | | |

HUGO LIGHTING



www.hugolighting.com



info@hugolighting.com



(+64)3 942 1272



2/22 Sonter Road, Wigram,
Christchurch, New Zealand 8042

